

USER AND INSTALLATION MANUAL

Ecosine Evo Passive Harmonic Filters



Revision: 10 (July 2023)
English version (original instructions)

The most current edition of this document (PDF format) can be obtained from your contact of the Schaffner organization or at schaffner.com/downloads.

Other technical documentation of our products is also available in the download area of our website schaffner.com.

Document name:
User and installation manual Ecosine Evo Passive Harmonic Filters rev10.pdf

Valid for Ecosine Evo Passive Harmonic Filters version:

- FN3440/FN3441 (50 Hz) for 380–415 VAC
- FN3450/FN3451 (50 Hz) for 440–500 VAC
- FN3442/FN3443 (60 Hz) for 380–415 VAC
- FN3452/FN3453 (60 Hz) for 440–480 VAC

Version history

Revision	Date	Description
01	November 2016	Initial version
02	February 2017	FN3441/51/53 and IP 20 types added
03	July 2017	SCCR
04	January 2018	Update filter selection table of FN3441/51/53 (min. required Lac, Ldc included)
05	October 2018	Add new filter series FN3442 and FN3443 (60 Hz, 380VAC)
06	January 2019	Power terminal table (Table 1) updated. Additional information regarding connecting power terminals with TDJ module in the way added
07	September 2019	Filter earth terminal table (Table 1) updated. Add new filters FN3440/41-250-119 and FN3450/51-315-119 and information about the applied new frame size J
08	October 2020	Template harmonization Typo corrections. Better harmonization of technical terms within the document and between products line Weight update (design change for some versions) Section 3.1 to 3.4 correction of the MTBF rated voltage. Rework of section 3.6 for addition of trap disconnect jumper terminals cables requirement and harmonization. Section 3.7 added - thermal switch specifications
09	April 2023	Template update for new branding Section 3.5.2 current derating by altitude, new calculation. Dimensions correction for frame size G dimension Z IP00
10	July 2023	WARNING: Section 8.3 part 5 important correction regarding the sizing of the capacitor used with the filters that have the TDJ option.

i. Ecosine Evo Passive Harmonic Filters product highlights

Schaffner Ecosine Evo Passive Harmonic Filters are configurable products which provide a tailored solution to each specific problem of current harmonics mitigation of 3-phase non-linear loads.

The eight product lines, FN3440/FN3441, FN3450/FN3451, FN3442/FN3443 and FN3452/FN3453 are applicable for low voltage 50 Hz and 60 Hz systems and they are particularly suitable for AC and DC motor drives, battery chargers and other power electronics applications with 6-pulse front-end rectifiers.

Ecosine Evo Passive Harmonic Filters technology represents an evolution of the previous generations of passive harmonic filters and introduces following aspects of novelty:

- **Ecosine Evo is designed for the most demanding harmonic mitigation tasks.** Ecosine Evo filters FN3440, FN3450, FN3442 and FN3452 are designed for three-phase diode and thyristor rectifier, to achieve THDi $\leq 5\%$ even without DC-link choke included in the drive. If there is 8% DC link choke present in the drive, Ecosine Evo filters FN3441, FN3451, FN3443 and FN3453 help to achieve 5% THDi @ rated power. The new generation Ecosine Evo filters guarantee compliance with the toughest requirement of IEEE-519 and other stringent international power quality standards.
- **Ecosine Evo demonstrates superior partial load performance.** The excellent performance of Ecosine Evo filters not only reflects on mitigating harmonic current and bringing the THDi down to 5% (diode rectifiers @ rated power), but also introducing minimum reactive power, even at partial or no-load condition. The displacement power factor remains at $\cos\phi > 0.98$ @ 50% load.
- **The modular concept of Ecosine Evo offers optimal tailored solution.** Ecosine Evo are configurable filters, optional modules include fan with aux. power supply, fan without aux. power supply, trap disconnect jumper and RC damper modules. Optimal solutions can be achieved by merely plugging a new module according to different installation conditions and drive setups. Most compact design, robust, reliable and ready to use.
The Schaffner power quality simulator SchaffnerPQS3 (pqs.schaffner.com) provides the possibility to simulate Ecosine Evo Passive Harmonic Filters within an electrical system. It furthermore offers quick and accurate performance checks.

This user manual is intended to support designers, installers, and application engineers with filter selection, installation, application, and maintenance. It provides helpful solutions to overcome harmonics mitigation challenges and answers frequently asked questions.

If you require additional support, please feel free to contact your local Schaffner representative.

ii. Performance Guarantee

By selecting and installing the appropriate Ecosine Evo Passive Harmonic Filters in a variable frequency AC drive application, variable speed drive application within our published technical specifications, we guarantee that the input current distortion will be less than or equal to 5% THDi for standard Ecosine Evo series filters at rated power. Ecosine Evo filters can also provide similar performance in other drive applications such as constant torque, DC drives or other phase controlled rectifiers, e.g. SCR drives, but actual THDi levels can vary by load and/or speed and/or firing angle of thyristors and therefore cannot be guaranteed. Consult your local Schaffner representative for assistance when applying ecosine filters on these types of equipment.

iii. Minimum system Requirements

The guaranteed performance levels of this filter will be achieved when the following system conditions are met:

- Type of load: Any 3-phase equipment with front-end six-pulse diode rectifier, with (FN3441/43/51/53) or without DC-link choke (FN3440/42/50/52).
- Type of source: 3-phase power line without neutral
- Line impedance: <3% (calculated for the rated filter power)
- Line frequency: 50 Hz \pm 1 Hz (FN3440/41, FN3450/51), 60 Hz \pm 1 Hz (FN3442/43, FN3452/53)
- Line voltage: Nominal line voltage \pm 10%
- Line voltage unbalance: <1%
- Line voltage distortion: THVD <2%

If a properly sized and installed filter fails to meet the 5% THDi level, Schaffner will provide the necessary application engineering support or filter replacement at no charge.

iv. Important user notice



Schaffner Ecosine Evo Passive Harmonic Filters are designed for the operation on the input (grid) side of power electronic equipment with six-pulse rectifier front-end in balanced three-phase power systems, like typically used in AC or DC motor drives and high power DC supplies. Filter suitability for a given application must be determined by the user on a case by case basis. Schaffner will not assume liability for any consequential downtimes or damages resulting from use or application of ecosine filters outside of their specifications. Ecosine filters are not designed for single-phase or split-phase applications.

v. General Safety Notes and Installation Guidelines (Cautions and Warnings)

1. Important Information

These general safety notes refer to the group of power quality filters including active and passive harmonic filter (AHF, PHF), AC line chokes and output filters. Do not attempt to install, operate, maintain or inspect power quality filters until you have read through the safety notes and installation guidelines as well as installation manual and product specification. Do not use any Schaffner product until you have a full knowledge of the equipment, safety notes and installation guidelines. The same applies to all warnings placed on the filters. Please ensure that those are not removed and their legibility is not influenced by external factors.

The following symbols, terms and designations are used in these general safety notes and installation guidelines:

Label	Description
 CAUTION	Follow these instructions to avoid hazardous conditions which could cause minor or moderate injury or may cause damages to the unit.
 WARNING	Follow these instructions to avoid hazardous conditions which could result in death or serious injury.
NOTICE	Indicates content to be noted by the reader.

2. General Installation Notes

- ▶ Please read and follow the safety and application notes below.
- ▶ Carefully inspect the shipping container and the product prior to the installation. In case of visual damage, don't install the filter and file a claim with the freight carrier involved.
- ▶ Filters may be heavy. Follow the instructions for lifting heavy equipment defined by your company.
- ▶ Use an appropriately sized threaded bolt for every mounting hole/slot provided by the filter flange. The strength class of the bolt must be determined by the installer, depending upon filter weight and the material of the mounting surface.
- ▶ Connect the filter to the protective earth (PE) terminal(s).
- ▶ Remove all line side power, then connect the phase terminal(s) and neutral terminal (if any) of the filter. The filter label may also indicate LINE (grid side terminals) and LOAD (power electronics terminals).
- ▶ For the electrical connection of the filter terminals, apply the torques recommended on the filter label and/or in the published filter datasheets.
- ▶ Cable or busbar cross sections have to be chosen in accordance with national and international electric codes and applicable product standards governing the equipment that will incorporate the power quality filters and the equipment in use.
- ▶ Some filters provide additional terminals, e.g. for over-temperature monitoring. These features have to be properly used before energizing the filter. If uncertain, please consult your local Schaffner representative.
- ▶ Active Harmonic Filters (AHF) are working with current transformers (CTs) which are a 3rd party product and which are typically installed in electrical equipment with lethal high voltage levels. Before attempting to install CTs read the CT installation safety page provided by the CT manufacturer. Always consider transformer as a part of the circuit to which it is connected, and do not touch the leads and terminals or other parts of the transformer unless they are known to be grounded.
- ▶ In order to get the maximum benefit out of your power quality filter, please also consult additional user manuals, installation manuals, whitepaper and other material, published in the download section of www.schaffner.com. These additional guidelines provide helpful hints for equipment related topics as well as technical knowledge.

3. Safety Notes and Regulations



















1. Label on equipment 2. Safety note category	Safety note regulations
 	Equipment installation, start-up, operation and maintenance (if any) have to be carried out by a trained and certified electrician or technician, who is familiar with safety procedures in electrical systems. Non-qualified persons are not allowed to use, install, operate or maintain PQ filters!
 	High voltage potentials are involved in the operation of power quality equipment. Always remove power before handling energized parts of the filter, and let ample time elapse for the capacitors to discharge to safe levels (<42V). Residual voltages are to be measured both line to line and line to earth.
 	Correct protective earthing of the equipment must be established and the user must be protected against supply voltage in accordance with applicable national and local regulations. Always practice the safety procedures defined by your company and by applicable national electric codes when handling, installing, operating or maintaining electrical equipment.
 	Some product may include EMC filters which may cause leakage currents to ground. Always connect the filter to protective earth (PE) first, then continue with the wiring of phase/neutral terminals. When decommissioning the filter, remove the PE connection at the end.
 	Using the direct OFF setting in AHF does not disconnect the equipment from mains and is thus not to be used as a safety switch.
 	Follow the general installation and environmental condition notes closely. Ensure that cooling slots (if any) are free from obstructions that could inhibit efficient air circulation. Operate the filter within its electrical, mechanical, thermal and ambient specifications at all times.
 	Power quality filters are lossy electrical components. Parts/surfaces of the equipment may get hot under load operating conditions.
	At altitudes above 2000m, please contact Schaffner prior to installation.
	Filter suitability for a given application must ultimately be determined by the user (the party that is putting the filter into operation) on a case by case basis. Schaffner will not assume liability for any consequential downtimes or damages resulting from use of filters outside their specifications.
 	In case of uncertainty and questions please contact your local Schaffner partner for assistance (details per region available at www.schaffner.com).

Table of Contents

1 Ecosine Evo Passive Harmonic Filters designation.....	9
1.1 Distinguishing between FN3440/FN3441, FN3450/FN3451, FN3442/FN3443 and FN3452/FN3453.....	9
1.2 Explanation of Ecosine Evo designation.....	9
1.2.1 Examples of Ecosine Evo filter designations	11
2 Filter selection.....	12
2.1 Filter selection table FN3440/FN3441 (50 Hz, 3×380 ... 415 VAC).....	15
2.2 Filter selection table FN3450/FN3451 (50 Hz, 3×440 ... 500 VAC).....	17
2.3 Filter selection table FN3442/FN3443 (60 Hz, 3×380 ... 415 VAC).....	19
2.4 Filter selection table FN3452/FN3453 (60 Hz, 3×440 ... 480 VAC).....	21
2.5 Filter configurations and designations if external air flow is available for cooling.....	23
2.7 Filter configurations and designation with embedded ventilation.....	24
2.9 Filter configurations and designation if external aux. power supply for the fan is available	25
2.10 Frame size J Filter configuration (FN3440/41-250-119, FN3450/51-315-119)	26
3 Filter description.....	27
3.1 General electrical specifications FN3440/FN3441 (50 Hz filters)	27
3.2 General electrical specifications FN3450/FN3451 (50 Hz filters)	28
3.3 General electrical specifications FN3442/FN3443 (60 Hz filters)	29
3.4 General electrical specifications FN3452/FN3453 (60 Hz filters)	30
3.5 Additional electrical specifications.....	31
3.5.1 Clearance derating by altitude.....	31
3.5.2 Current derating by altitude	31
3.6 Screw size, torque and cable cross-section requirement.....	31
3.6.1 Power terminals.....	31
3.6.2 Trap disconnect jumper terminals	32
3.6.3 Auxiliary signal and earth terminals.....	33

3.7	Thermal protection switch specifications	33
3.8	Cooling requirement.....	34
3.9	Mechanical frame sizes.....	35
3.10	Ecosine Evo filter footprint.....	37
3.11	Filter performance	39
3.12	Functional diagram.....	41
4	Modular Design: How to choose optional modules.....	42
5	Filter appearance and elements.....	44
5.1	IP 00 version, frame size A - F	44
5.2	IP 00 version, frame size G - H	45
5.3	IP 00 version, frame size J	45
5.4	IP 20 version	46
6	Performance estimation using SchaffnerPQS	49
7	Filter application	50
8	Filter installation	51
8.1	Step 1: Visual inspection	51
8.2	Step 2: Mounting.....	51
8.2.1	Fixation	52
8.2.1	Screws and bolts selection	52
8.2.2	Filter placement:	52
8.3	Step 3: Wiring.....	53
8.3.1	Verify safe disconnection of all line side power.....	53
8.3.2	Carefully connect protective earth (PE) wire to adequate earth potential close to ecosine filter. 53	
8.3.3	Connect PE wire of ecosine filter	53
8.3.4	Connect ecosine load side terminals L1', L2', L3' to respective motor drive or rectifier inputs. 54	
8.3.5	Use wired trap circuit or install external capacitive current control.	55
8.3.6	Connect monitor switch TS- TS'	55
8.3.7	Connect auxiliary switch AS- AS'	56

8.3.8	Connect ecosine line side terminals L1, L2, L3 to power input protection (current limiting fuses – see below).....	56
8.3.9	Fuses.....	57
9	Filter maintenance	60
9.1	Maintenance schedule	60
9.2	Fan	60
9.3	Power capacitors	61
9.3.1	Note regarding the storage of capacitors	61
9.4	Electrical connections.....	61
10	Trap circuit disconnect	62
11	Troubleshooting	63
12	Abbreviation	63

1 Ecosine Evo Passive Harmonic Filters designation

1.1 Distinguishing between FN3440/FN3441, FN3450/FN3451, FN3442/FN3443 and FN3452/FN3453

Before going into the details of the designation, it is important to be aware of the difference between FN3440 and FN3441, FN3450 and FN3451, FN3442 and FN3443, FN3452 and FN3453. FN3440, FN3450, FN3442 and FN3452 are used for motor drives without dc-link choke. They are similar to FN3441, FN3451, FN3443 and FN3453 except there is one choke less in FN3441, FN3451, FN3443 and FN3453 series as they are meant to be used for motor drives with dc-link choke (8%) included. In other words, there are three chokes (line choke, trap choke and load choke) included in filter series FN3440, FN3450, FN3442 and FN3452, whereas there are only two chokes (line choke, trap choke) included in filter series FN3441, FN3451, FN3443 and FN3453 series.

By distinguishing between FN3440, (FN3450, FN3442, FN3452) as well as FN3441 (FN3451, FN3443, FN3453) Schaffner is able to provide optimized solutions for different drive types:

- If there is no DC-link choke present in the motor drive, FN3440, FN3450, FN3442, FN3452 filter series help to reduce THDi to 5% @ rated power.
- If there is a minimum 8% DC-link choke present in the motor drive, FN3441, FN3451, FN3443, FN3453 filter series reduce THDi to 5% @ rated power

In case you have difficulties selecting the right filter, please contact your local Schaffner representative for support.

1.2 Explanation of Ecosine Evo designation

Ecosine Evo is the new generation of Schaffner passive harmonic filter. They are introduced with a new designation system, which contains of 4 sections connected with '-' as shown in

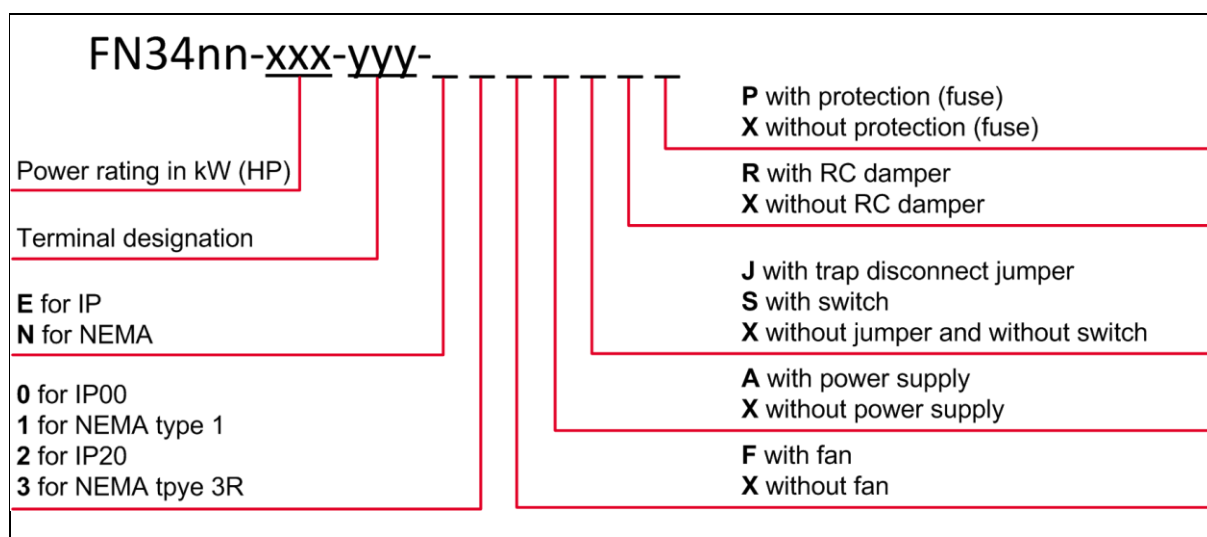

Figure 1 Ecosine Evo designation

- The first part of the designation ‘FN34nn-xxx-yyy-_____’ distinguishes between the six Ecosine Evo filter series.

Table 1 filter application, operating frequency and nominal voltage per filter type

	FN3440	FN3441	FN3450	FN3451	FN3442	FN3443	FN3452	FN3453
For 6-pulse diode rectifier without DC-link choke	✓		✓		✓		✓	
For 6-pulse diode rectifier with 8% DC-link choke		✓		✓		✓		✓
For SCR rectifier	✓		✓		✓		✓	
Operating frequency	50 Hz		50 Hz		60 Hz		60 Hz	
Nominal operating voltage	3x 380 to 415 VAC		3x 440 to 500 VAC		3x 380 to 415 VAC		3x 440 to 480 VAC	

- The second part of the designation ‘FN34nn-xxx-yyy-_____’ indicates the **motor drive power rating**, in kW for 50 Hz filters and in HP for 60 Hz filters. Please note that Ecosine Evo filters are not using current rating in the designation anymore.
- The third part of the designation ‘FN34nn-xxx-yyy-_____’ indicates the power terminal type. For more information please see section 3.6.1.
- The fourth part of the designation ‘FN34nn-xxx-yyy-_____’ contains seven slots, the first two slots reveal the protection category of the filter, e.g. E0 and E2 represent IP 00 and IP 20 enclosure, while N1 and N3 represent NEMA type1 and NEMA type 3R, respectively. The following five slots represent the presence (F,A,R,J,P) or absence (X) of optional modules in the filter, as shown in

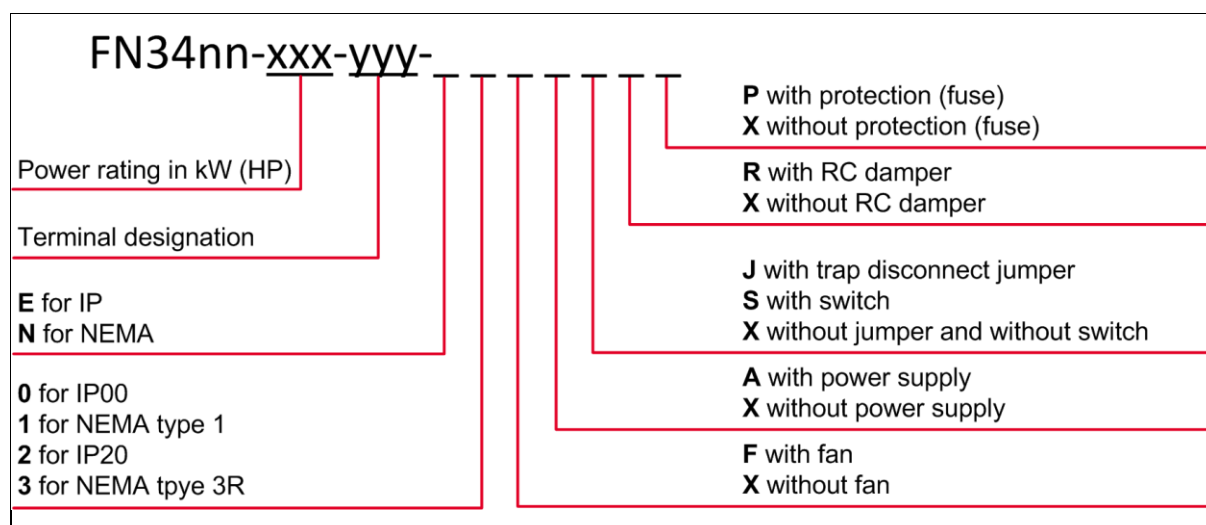

Figure 1. Please find more information in section 2.4, 2.5 and 2.6.

Schaffner offers an online **Product Configurator** (myecosine.com) and the Schaffner Power Quality Simulator **SchaffnerPQS3** (pqs.schaffner.com) to select and verify the most suitable Ecosine Evo filter for your application.

1.2.1 Examples of Ecosine Evo filter designations

FN3440-22-115-E0XXJRX: Filter for 50 Hz, 380–415 V AC grid, motor drive power rating 22kW without DC-link choke present, with 20mm² terminals, open frame (IP 00), filter contains trap disconnect jumper module and RC damper module.

FN3441-22-115-E2FAXXX: Filter for 50 Hz, 380–415 V AC grid, motor drive power rating 22kW with 8% DC-link choke present, with 20mm² terminals, IP 20 enclosure, filter contains Fan module and auxiliary power supply module.

FN3452-150-116-E0XXXXXX: Filter for 60 Hz, 440–480 V AC grid, motor drive power rating 150HP with no DC-link choke present, with 24mm² terminals, open frame (IP 00), filter contains no optional modules.

FN3440-250-119-E2FASXX: Filter for 50 Hz, 380–415 V AC grid, motor drive power rating 250kW with no DC-link choke present, IP20, filter contains Fan module, auxiliary power supply module and switch module.

2 Filter selection

Ecosine Evo Passive Harmonic Filters need to be carefully selected and configured in order to enjoy maximum benefits. Besides the enclosed selection tables and the product datasheets included in the online configurator (myecosine.com), Schaffner advises to verify the selection by using the Schaffner Power Quality Simulator tool SchaffnerPQS3, available at pqs.schaffner.com.

Step 1: Grid frequency

Determine, whether the system in consideration will be operated in a 50 Hz or 60 Hz electricity grid, and select the corresponding filter series according to the following table:

50 Hz grid	Europe, Middle East, parts of Asia, parts of South America	FN3440/FN3441 FN3450/FN3451
60 Hz grid	North and Central America, parts of Asia, parts of South America	FN3442/FN3443 FN3452/FN3453

Note: a 50 Hz filter will not provide satisfying harmonics mitigation in a 60 Hz grid, and vice versa.

Step 2: Grid voltage

Verify that the grid configuration is suitable for standard Ecosine Evo Passive Harmonic Filters according to the following table:

50 Hz grid	Nominal voltage 380–415 V AC	TN, TT, IT configuration
50 Hz grid	Nominal voltage 440–500 V AC	TN, TT, IT configuration
60 Hz grid	Nominal voltage 380–415 V AC	TN, TT, IT configuration
60 Hz grid	Nominal voltage 440–480 V AC	TN, TT, IT configuration

Step 3: Rectifier type, presence of DC-link choke in drive

	FN3440	FN3441	FN3450	FN3451	FN3442	FN3443	FN3452	FN3453
For 6-pulse diode rectifier without DC-link choke	✓		✓		✓		✓	
For 6-pulse diode rectifier with 8% DC-link choke		✓		✓		✓		✓
For SCR rectifier	✓		✓		✓		✓	

Note: For 6-pulse diode rectifier with DC-link choke smaller than 8%, it is recommended to choose FN3440, FN3450, FN3442 or FN3452 if 5% THDi is required.

Step 4: Rectifier/Drive input power

The individual filter must be selected with respect to the rectifier/motor drive input power in kW respectively in HP. It is important to match rated filter power as close as possible with the effective input power of the rectifier/drive.

Note that if the rectifier/drive is being operated very close to its rated power, then the filter can be selected by the motor drive's nominal power rating. However, if the drive will be operated e.g. at only 66% of its rated power, then a smaller filter should be selected in order to get maximum harmonics mitigation performance and the optimum in terms of cost, size, and weight. In that case the customer is responsible to ensure that ecosine passive harmonic filter will be operated within specification. This is particularly important in terms of overload.

Please refer to the following examples:

Example 1:

Power line rating: 400 V, 50 Hz

Drive rating: 380–500 V, 50–60 Hz, 15 kW, 22.5 A, B6-diode rectifier without DC-link choke

Planned rectifier/drive input real power: 15kW (100% of drive rating)

➔ Recommended filter according to the filter selection table FN3440: Type FN3440-15-113

Example 2:

Power line rating: 400 V, 50 Hz

Drive rating: 380–500 V, 50–60 Hz, 15 kW, 22.5 A, B6-diode rectifier with an 8% DC-link choke

Planned rectifier/drive input real power: 15 kW (100% of drive rating)

➔ Recommended filter according to the filter selection table FN3441: Type FN3441-15-113

Example 3:

Power line rating: 500 V, 50 Hz

Drive rating: 380–500 V, 50–60 Hz, 15 kW, 18 A, B6-diode rectifier without DC-link choke

Planned rectifier/drive input real power: 15 kW (100% of drive rating)

➔ Recommended filter according to the filter selection table FN3450: Type FN3450-15-113

Example 4:

Power line rating: 500 V, 50 Hz

Drive rating: 380–500 V, 50–60 Hz, 15 kW, 18 A, B6-thyristor rectifier

Planned rectifier/drive input real power: 15 kW (100% of drive rating)

➔ Recommended filter according to the filter selection table FN3450: Type FN3450-15-113

Example 5:

Power line rating: 400 V, 50 Hz

Drive rating: 380–500 V, 50–60 Hz, 15 kW, 22.5 A, diode rectifier

Planned rectifier/drive input real power: 10 kW (66% of drive rating)

➔ Recommended filter according to the filter selection table FN3440: Type FN3440-11-113

Example 6:

Power line rating: 480 V, 60 Hz

Drive rating: 380–500 V, 50–60 Hz, 30 HP, 41 A, diode rectifier

Planned rectifier/drive input real power: 30 HP (100% of drive rating)

➔ **Recommended filter according to the filter selection table FN3452: Type FN3452-30-113**

Oversizing of passive harmonic filters is not recommended because of the inherent lower harmonic mitigation performance at partial load as well as higher cost, size, and weight.

Please refer to Table 2 - Table 9 to select suitable filters.

2.1 Filter selection table FN3440/FN3441 (50 Hz, 3×380 ... 415 VAC)

Table 2 FN3440 filter selection table

Filter	Rated load power @400 V/50 Hz [kW]	Motor drive input current [Arms]**	Rated filter input current [Arms]	Weight [kg]	Typical losses [W]**	Terminal	Frame size
FN3440-1-110-E0_____*	1.1	3	1.63	7	61	110	A
FN3440-2-110-E0_____*	2.2	5.5	3.26	10	87	110	A
FN3440-4-112-E0_____*	4	10	5.93	13	135	112	B
FN3440-6-112-E0_____*	5.5	13	8.17	17	183	112	C
FN3440-8-112-E0_____*	7.5	16	11.1	21	256	112	C
FN3440-11-113-E0_____	11	24	16.3	28	287	113	D
FN3440-15-113-E0_____	15	32	22.2	32	359	113	D
FN3440-19-113-E0_____	19	38	28.2	33	343	113	D
FN3440-22-115-E0_____	22	45	32.5	48	460	115	E
FN3440-30-115-E0_____	30	60	44.4	49	570	115	E
FN3440-37-115-E0_____	37	75	54.8	60	581	115	E
FN3440-45-115-E0_____	45	90	66.7	67	783	115	E
FN3440-55-115-E0_____	55	110	81.6	69	858	115	E
FN3440-75-116-E0_____	75	150	111	118	1036	116	G
FN3440-90-116-E0_____	90	180	134	139	1166	116	G
FN3440-110-118-E0_____	110	210	164	158	1365	118	H
FN3440-132-118-E0_____**	132	260	197	176	1392	118	H
FN3440-160-118-E0_____**	160	320	240	202	1462	118	H
FN3440-200-118-E0_____**	200	400	300	210	1644	118	H
FN3440-250-119-E0XXSXX	250	530	376	324	1746	119	J

* Filter rating which does not require forced cooling or fan module

** Filter rating which does not require RC damping module for rectifiers with EMI filter

*** Motor drive input current without harmonic filter

**** Typical losses @ 45°C, 400V, 50Hz and rated load power

Table 3 FN3441 filter selection table

Filter	Rated load power @400 V/50 Hz [kW]	Motor drive input current [Arms]***	Rated filter input current [Arms]	Min. required Ldc [mH]*****	Min. required Lac [mH]*****	Weight [kg]	Typical losses [W]****	Terminal	Frame size
FN3441-1-110-E0_____*	1.1	1.7	1.62	37.41	9.8	6	53	110	A
FN3441-2-110-E0_____*	2.2	3.4	3.23	18.71	6.01	9	73	110	A
FN3441-4-112-E0_____*	4	6.2	5.9	10.29	3.48	12	104	112	B
FN3441-6-112-E0_____*	5.5	8.5	8.1	7.483	2.548	15	143	112	C
FN3441-8-112-E0_____*	7.5	12	11	5.487	1.818	16	193	112	C
FN3441-11-113-E0_____	11	17	16	3.741	1.264	23	233	113	D
FN3441-15-113-E0_____	15	23	22	2.744	0.909	26	285	113	D
FN3441-19-113-E0_____	19	29.3	28	2.166	0.724	30	271	113	D
FN3441-22-115-E0_____	22	34	32	1.871	0.637	38	355	115	E
FN3441-30-115-E0_____	30	46	44	1.372	0.454	43	452	115	E
FN3441-37-115-E0_____	37	57	54	1.112	0.361	48	468	115	E
FN3441-45-115-E0_____	45	70	66	0.915	0.297	54	596	115	E
FN3441-55-115-E0_____	55	85	81	0.748	0.245	63	665	115	E
FN3441-75-116-E0_____	75	116	110	0.549	0.178	98	757	116	G
FN3441-90-116-E0_____	90	140	133	0.457	0.147	106	854	116	G
FN3441-110-118-E0_____	110	171	162	0.374	0.12	127	1032	118	H
FN3441-132-118-E0_____**	132	205	195	0.312	0.099	149	1062	118	H
FN3441-160-118-E0_____**	160	249	238	0.257	0.085	167	1073	118	H
FN3441-200-118-E0_____**	200	312	297	0.206	0.064	169	1228	118	H
FN3441-250-119-E0XXSXX	250	392	376	0.165	0.051	246	1398	119	J

* Filter rating which does not require forced cooling or fan module

** Filter rating which does not require RC damping module for rectifiers with EMI filter

*** Motor drive input current without harmonic filter

**** Typical losses @ 45°C, 400V, 50Hz and rated load power

***** In order to apply FN3441 filters, motor drives have to be equipped with either DC-link choke or AC line choke. The minimum required inductance values are given in mH in the filter selection table. If neither DC-link choke nor AC line choke is present, or if the minimum mH rating is not fulfilled, FN3441 filter must not be used. In this case, FN3440 need to be chosen.

2.2 Filter selection table FN3450/FN3451 (50 Hz, 3×440 ... 500 VAC)

Table 4 FN3450 filter selection table

Filter	Rated load power @480 V/50 Hz	Motor drive input current	Rated filter input current	Weight	Typical losses	Terminal	Frame size
	[kW]	[Arms]**	[Arms]	[kg]	[W]***		
FN3450-1-110-E0_____*	1.1	1.5	1.35	6	49	110	A
FN3450-2-110-E0_____*	2.2	3	2.75	8	76	110	A
FN3450-4-112-E0_____*	4.4	5.5	4.99	11	132	112	B
FN3450-6-112-E0_____*	5.5	10	6.77	14	135	112	B
FN3450-8-112-E0_____*	7.5	13	9.24	17	183	112	C
FN3450-11-112-E0_____*	11	16	13.6	21	256	112	C
FN3450-15-113-E0_____	15	24	18.5	28	287	113	D
FN3450-19-113-E0_____	19	32	23.3	32	376	113	D
FN3450-22-113-E0_____	22	38	27.0	36	374	113	D
FN3450-30-115-E0_____	30	45	36.9	48	460	115	E
FN3450-37-115-E0_____	37	60	45.4	54	546	115	E
FN3450-45-115-E0_____	45	75	55.2	63	598	115	E
FN3450-55-115-E0_____	55	90	67.5	67	784	115	F
FN3450-75-115-E0_____	75	110	92.5	88	1036	115	F
FN3450-90-116-E0_____	90	150	111	120	1016	116	G
FN3450-110-116-E0_____	110	180	135	141	1083	116	G
FN3450-132-118-E0_____	132	210	163	161	1440	118	H
FN3450-160-118-E0_____**	160	260	198	181	1412	118	H
FN3450-200-118-E0_____**	200	320	248	217	1597	118	H
FN3450-250-118-E0_____**	250	400	310	244	1745	118	H
FN3450-315-119-E0XXSXX	315	425	392	331	2025	119	J

* Filter rating which does not require forced cooling or fan module

** Filter rating which does not require RC damping module for rectifiers with EMI filter

*** Motor drive input current without harmonic filter

**** Typical losses @ 45°C, 480V, 50Hz and rated load power

Table 5 FN3451 filter selection table

Filter	Rated load power @480 V/50 Hz	Motor drive input current	Rated filter input current	Min. required Ldc	Min. required Lac	Weight	Typical losses	Terminal	Frame size
	[kW]	[Arms]**	[Arms]	[mH]*****	[mH]*****	[kg]	[W]****		
FN3451-1-110-E0_____*	1.1	1.4	1.3	53.9	16.7	5	40	110	A
FN3451-2-110-E0_____*	2.2	2.8	2.7	26.9	7.85	7	61	110	A
FN3451-4-112-E0_____*	4	5.1	4.9	14.8	4.47	10	104	112	B
FN3451-6-112-E0_____*	5.5	7.1	6.7	10.8	3.48	12	104	112	B
FN3451-8-112-E0_____*	7.5	9.6	9.2	7.90	2.55	15	143	112	C
FN3451-11-112-E0_____*	11	14.1	13.4	5.39	1.82	17	193	112	C
FN3451-15-113-E0_____	15	19.3	18.3	3.95	1.26	24	233	113	D
FN3451-19-113-E0_____	19	24.4	23.0	3.12	1.02	27	292	113	D
FN3451-22-113-E0_____	22	28.0	27.0	2.69	0.88	31	274	113	D
FN3451-30-115-E0_____	30	38.5	36.6	1.98	0.64	38	355	115	E
FN3451-37-115-E0_____	37	47.5	45.0	1.60	0.527	43	426	115	E
FN3451-45-115-E0_____	45	58	55	1.32	0.451	49	458	115	E
FN3451-55-115-E0_____	55	71	67	1.08	0.357	54	611	115	F
FN3451-75-115-E0_____	75	97	92	0.790	0.265	70	781	115	F
FN3451-90-116-E0_____	90	116	110	0.660	0.218	100	740	116	G
FN3451-110-116-E0_____	110	142	135	0.540	0.176	108	799	116	G
FN3451-132-118-E0_____	132	170	162	0.450	0.149	130	1063	118	H
FN3451-160-118-E0_____**	160	207	197	0.370	0.118	149	1039	118	H
FN3451-200-118-E0_____**	200	259	246	0.300	0.094	183	1232	118	H
FN3451-250-118-E0_____**	250	324	308	0.240	0.073	208	1262	118	H
FN3451-315-119-E0XXSXX	315	410	392	0.188	0.059	252	1553	119	J

* Filter rating which does not require forced cooling or fan module

** Filter rating which does not require RC damping module for rectifiers with EMI filter

*** Motor drive input current without harmonic filter

**** Typical losses @ 45°C, 480V, 50Hz and rated load power

***** In order to apply FN3451 filters, motor drives have to be equipped with either DC-link choke or AC line choke. The minimum required inductance values are given in mH in the filter selection table. If neither DC-link choke nor AC line choke is present, or if the minimum mH rating is not fulfilled, FN3451 filter must not be used. In this case, FN3450 need to be chosen.

2.3 Filter selection table FN3442/FN3443 (60 Hz, 3×380 ... 415 VAC)

Table 6 FN3442 filter selection table

Filter	Rated load power @380 V/60 Hz		Motor drive input current	Rated filter input current	Weight		Typical losses	Terminal	Frame size
	[kW]	[HP]	[Arms]***	[Arms]	[kg]	[lbs]	[W]****		
FN3442-1-110-E0_____*	0.9	1.2	2	1.37	6	12.6	50	110	A
FN3442-2-110-E0_____*	1.7	2.4	4	2.74	8	17.4	67	110	A
FN3442-4-112-E0_____*	2.9	4	7	4.57	10	22	116	112	B
FN3442-6-112-E0_____*	4.4	6	11	6.91	13	29	132	112	B
FN3442-8-112-E0_____*	5.9	8	14	9.29	16	35	160	112	C
FN3442-12-112-E0_____*	8.7	12	21	13.8	18	40	237	112	C
FN3442-16-113-E0_____	11.9	16	27	18.5	27	60	294	113	D
FN3442-20-113-E0_____	15	20	34	23.1	31	68	351	113	D
FN3442-24-113-E0_____	17.4	24	44	27.8	36	79	354	113	D
FN3442-32-115-E0_____	23.8	32	52	37.2	46	101	459	115	E
FN3442-40-115-E0_____	29.3	40	66	46.2	51	112	571	115	E
FN3442-48-115-E0_____	35.6	48	83	55.6	59	130	589	115	E
FN3442-60-115-E0_____	44.3	60	103	69.3	60	132	821	115	F
FN3442-80-115-E0_____	59.4	80	128	92.5	82	181	1028	115	F
FN3442-100-116-E0_____	73.6	100	165	115	116	256	1067	116	G
FN3442-120-116-E0_____	88.7	120	208	139	137	302	1143	116	G
FN3442-160-118-E0_____	118	160	240	184	170	375	1538	118	H
FN3442-200-118-E0_____**	147.3	200	320	231	187	412	1411	118	H
FN3442-240-118-E0_____**	177.3	240	403	279	252	556	1775	118	H

* Filter rating which does not require forced cooling or fan module

** Filter rating which does not require RC damping module for rectifiers with EMI filter

*** Motor drive input current without harmonic filter

**** Typical losses @ 45°C, 380V, 60Hz and rated load power

Table 7 FN3443 filter selection table

Filter	Rated load power @380 V/60 Hz		Motor drive input current	Rated filter input current	Min. required Ldc	Min. required Lac	Weight		Typical losses	Terminal	Frame size
	[kW]	[HP]	[Arms]***	[Arms]	[mH]*****	[mH]*****	[kg]	[lbs]	[W]****		
FN3443-1-110-E0_____*	0.9	1.2	1.4	1.37	21.5	11.61	5	11	41	110	A
FN3443-2-110-E0_____*	1.7	2.4	2.9	2.74	18.2	6.145	7	15	53	110	A
FN3443-4-112-E0_____*	2.9	4	4.8	4.52	10.7	3.602	9	20	88	112	B
FN3443-6-112-E0_____*	4.4	6	7.2	6.85	7.04	2.374	12	25	101	112	B
FN3443-8-112-E0_____*	5.9	8	9.6	9.20	5.25	1.771	14	30	123	112	C
FN3443-12-112-E0_____*	8.7	12	14.4	13.7	3.56	1.201	16	34	183	112	C
FN3443-16-113-E0_____	11.9	16	19.3	18.3	2.61	0.880	23	51	228	113	D
FN3443-20-113-E0_____	15	20	24.0	23.0	2.06	0.696	26	56	277	113	D
FN3443-24-113-E0_____	17.4	24	29.0	27.5	1.78	0.600	30	66	282	113	D
FN3443-32-115-E0_____	23.8	32	38.5	36.8	1.30	0.434	37	82	370	115	E
FN3443-40-115-E0_____	29.3	40	48.0	45.8	1.06	0.357	42	92	453	115	E
FN3443-48-115-E0_____	35.6	48	58.0	55	0.869	0.293	48	106	476	115	E
FN3443-60-115-E0_____	44.3	60	72.0	69	0.699	0.236	49	108	634	115	F
FN3443-80-115-E0_____	59.4	80	97.0	92	0.521	0.176	68	149	779	115	F
FN3443-100-116-E0_____	73.6	100	120	114	0.421	0.142	97	214	788	116	G
FN3443-120-116-E0_____	88.7	120	144	138	0.349	0.118	113	250	831	116	G
FN3443-160-118-E0_____	118	160	192	183	0.262	0.089	138	305	1199	118	H
FN3443-200-118-E0_____**	147.3	200	240	229	0.210	0.071	152	336	1022	118	H
FN3443-240-118-E0_____**	177.3	240	290	277	0.175	0.059	205	452	1292	118	H

* Filter rating which does not require forced cooling or fan module

** Filter rating which does not require RC damping module for rectifiers with EMI filter

*** Motor drive input current without harmonic filter

**** Typical losses @ 45°C, 380V, 60Hz and rated load power

***** In order to apply FN3443 filters, motor drives have to be equipped with either DC-link choke or AC line choke. The minimum required inductance values are given in mH in the filter selection table. If neither DC-link choke nor AC line choke is present, or if the minimum mH rating is not fulfilled, FN3443 filter must not be used. In this case, FN3442 need to be chosen.

2.4 Filter selection table FN3452/FN3453 (60 Hz, 3×440 ... 480 VAC)

Table 8 FN3452 filter selection table

Filter	Rated load power @480 V/60 Hz		Motor drive input current	Rated filter input current	Weight		Typical losses	Terminal	Frame size
	[kW]	[HP]	[Arms]***	[Arms]	[kg]	[lbs]	[W]****		
FN3452-1-110-E0_____*	1.1	1.5	2	1.37	6	13	50	110	A
FN3452-3-110-E0_____*	2.2	3	4	2.76	8	18	67	110	A
FN3452-5-112-E0_____*	3.7	5	7	4.57	10	22	116	112	B
FN3452-8-112-E0_____*	5.6	7.5	11	6.91	13	29	132	112	B
FN3452-10-112-E0_____*	7.5	10	14	9.29	16	35	160	112	C
FN3452-15-112-E0_____*	11	15	21	13.8	18	40	237	112	C
FN3452-20-113-E0_____	15	20	27	18.5	27	60	294	113	D
FN3452-25-113-E0_____	19	25	34	23.1	31	68	351	113	D
FN3452-30-113-E0_____	22	30	44	27.8	36	79	354	113	D
FN3452-40-115-E0_____	30	40	52	37.2	46	101	459	115	E
FN3452-50-115-E0_____	37	50	66	46.2	51	112	571	115	E
FN3452-60-115-E0_____	45	60	83	55.6	59	130	589	115	E
FN3452-75-115-E0_____	56	75	103	69.3	60	132	821	115	F
FN3452-100-115-E0_____	75	100	128	92.5	82	181	1028	115	F
FN3452-125-116-E0_____	93	125	165	115	116	256	1067	116	G
FN3452-150-116-E0_____	112	150	208	139	137	302	1143	116	G
FN3452-200-118-E0_____	149	200	240	184	170	375	1538	118	H
FN3452-250-118-E0_____**	186	250	320	231	187	412	1411	118	H
FN3452-300-118-E0_____**	224	300	403	279	252	556	1775	118	H

* Filter rating which does not require forced cooling or fan module

** Filter rating which does not require RC damping module for rectifiers with EMI filter

*** Motor drive input current without harmonic filter

**** Typical losses @ 45°C, 480V, 60Hz and rated load power

Table 9 FN3453 filter selection table

Filter	Rated load power @480 V/60 Hz		Motor drive input current	Rated filter input current	Min. required Ldc	Min. required Lac	Weight		Typical losses	Terminal	Frame size
	[kW]	[HP]	[Arms]***	[Arms]	[mH]*****	[mH]*****	[kg]	[lbs]	[W]****		
FN3453-1-110-E0_____*	1.1	1.5	1.44	1.37	44.1	14.0	5	11	41	110	A
FN3453-3-110-E0_____*	2.2	3.0	2.87	2.74	22.1	6.89	7	15	53	110	A
FN3453-5-112-E0_____*	3.7	5.0	4.75	4.52	13.4	4.47	9	20	88	112	B
FN3453-8-112-E0_____*	5.6	7.5	7.18	6.85	8.82	2.81	12	26	101	112	B
FN3453-10-112-E0_____*	7.5	10	9.60	9.20	6.59	2.14	13	29	123	112	C
FN3453-15-112-E0_____*	11	15	14.4	13.7	4.41	1.46	16	35	183	112	C
FN3453-20-113-E0_____	15	20	19.3	18.3	3.29	1.08	23	51	228	113	D
FN3453-25-113-E0_____	19	25	24.0	23.0	2.64	0.858	26	57	277	113	D
FN3453-30-113-E0_____	22	30	29.0	27.5	2.20	0.724	30	66	282	113	D
FN3453-40-115-E0_____	30	40	38.5	36.8	1.65	0.531	37	82	370	115	E
FN3453-50-115-E0_____	37	50	48	45.8	1.32	0.433	42	93	453	115	E
FN3453-60-115-E0_____	45	60	58	55	1.10	0.361	48	106	476	115	E
FN3453-75-115-E0_____	56	75	72	69	0.882	0.297	49	108	634	115	F
FN3453-100-115-E0_____	75	100	97	92	0.658	0.214	68	150	779	115	F
FN3453-125-116-E0_____	93	125	120	114	0.531	0.178	97	214	788	116	G
FN3453-150-116-E0_____	112	150	144	138	0.441	0.147	113	249	831	116	G
FN3453-200-118-E0_____	149	200	192	183	0.331	0.106	138	304	1199	118	H
FN3453-250-118-E0_____**	186	250	241	229	0.266	0.085	152	335	1022	118	H
FN3453-300-118-E0_____**	224	300	290	277	0.220	0.073	205	452	1292	118	H

* Filter rating which does not require forced cooling or fan module

** Filter rating which does not require RC damping module for rectifiers with EMI filter

*** Motor drive input current without harmonic filter

**** Typical losses @ 45°C, 480V, 60Hz and rated load power

***** In order to apply FN3453 filters, motor drives have to be equipped with either DC-link choke or AC line choke. The minimum required inductance values are given in mH in the filter selection table. If neither DC-link choke nor AC line choke is present, or if the minimum mH rating is not fulfilled, FN3453 filter must not be used. In this case, FN3452 need to be chosen.

2.5 Filter configurations and designations if external air flow is available for cooling

If there is external air flow available for cooling in the installation, then the filters do **not contain fan** and do **not contain aux. power supply**.

The filter configurations are shown in Table 10 and Table 11, if external air flow is available for cooling, Table 10 FN3440, FN3450, FN3452 filter configurations if external air flow available for cooling

E0XXXXX	E0XXJXX	E0XXRX	E0XXJRX
- For rectifiers without DC-link choke	- For rectifiers without DC-link choke - Filters contain trap disconnect jumper	- For rectifiers without DC-link choke and with EMI filter - Filters contain RC damper module	- For rectifiers without DC-link choke and with EMI filter - Filters contain RC damper module and trap disconnect jumper

Table 11 FN3441, FN3451, FN3453 filter configurations if external air flow available for cooling

E0XXXXX	E0XXJXX	E0XXRX	E0XXJRX
- For rectifiers with DC-link choke	- For rectifiers with DC-link choke - Filters contain trap disconnect jumper	- For rectifiers with DC-link choke and with EMI filter - Filters contain RC damper module	- For rectifiers with DC-link choke and with EMI filter - Filters contain RC damper module and trap disconnect jumper

2.7 Filter configurations and designation with embedded ventilation

If external air flow for cooling is not available, then the filters contain embedded ventilation, which means the filters **contain fan and aux. power supply**.

The open frame filter configurations are shown in Table 12 and Table 13, if external air flow is not available and embedded ventilation is equipped.

Table 12 FN3440, FN3450, FN3452 filter configurations with embedded ventilation

E0FAXXX and E2FAXXX	E0FAJXX and E2FAJXX	E0FAXRX and E2FAXRX	E0FAJRX and E2FAJRX
<ul style="list-style-type: none"> - For rectifiers without DC-link choke - Filters contain fan and aux. power supply 	<ul style="list-style-type: none"> - For rectifiers without DC-link choke - Filters contain fan, aux. power supply and trap disconnect jumper 	<ul style="list-style-type: none"> - For rectifiers without DC-link choke and with EMI filter - Filters contain fan, aux. power supply and RC damper module 	<ul style="list-style-type: none"> - For rectifiers without DC-link choke and with EMI filter - Filters contain fan, aux. power supply, RC damper module and trap disconnect jumper

Table 13 FN3441, FN3451, FN3453 filter configurations with embedded ventilation

E0FAXXX and E2FAXXX	E0FAJXX and E2FAJXX	E0FAXRX and E2FAXRX	E0FAJRX and E2FAJRX
<ul style="list-style-type: none"> - For rectifiers with DC-link choke - Filters contain fan and aux. power supply 	<ul style="list-style-type: none"> - For rectifiers with DC-link choke - Filters contain fan, aux. power supply and trap disconnect jumper 	<ul style="list-style-type: none"> - For rectifiers with DC-link choke and with EMI filter - Filters contain fan, aux. power supply and RC damper module 	<ul style="list-style-type: none"> - For rectifiers with DC-link choke and with EMI filter - Filters contain fan, aux. power supply, RC damper module and trap disconnect jumper

Remark: Frame sizes A, B, C do not require air-flow for cooling hence they are not equipped with FAN and AUX.

2.9 Filter configurations and designation if external aux. power supply for the fan is available

If there is an external 24 V DC power supply available to the fan, then the filters **contain fan** but do **not contain auxiliary power supply**, user should provide aux. power supply to the fan.

The open frame filter configurations are shown in Table 14 and Table 15, if external air flow is not available but external auxiliary power supply for the fan is available.

Table 14 FN3440, FN3450, FN3452 filter configurations if external auxiliary power supply for the fan is available

E0FXXXX and E2FXXXX	E0FXJXX and E2FXJXX	E0FXXRX and E2FXXRX	E0FXJRX and E2FXJRX
- For rectifiers without DC-link choke - Filters contain fan	- For rectifiers without DC-link choke - Filters contain fan and trap disconnect jumper	- For rectifiers without DC-link choke and with EMI filter - Filters contain fan and RC damper module	- For rectifiers without DC-link choke and with EMI filter - Filters contain fan, RC damper module and trap disconnect jumper

Table 15 FN3441, FN3451, FN3453 filter configurations if external auxiliary power supply for the fan is available

E0FXXXX and E2FXXXX	E0FXJXX and E2FXJXX	E0FXXRX and E2FXXRX	E0FXJRX and E2FXJRX
- For rectifiers without DC-link choke - Filters contain fan	- For rectifiers without DC-link choke - Filters contain fan and trap disconnect jumper	- For rectifiers without DC-link choke and with EMI filter - Filters contain fan and RC damper module	- For rectifiers without DC-link choke and with EMI filter - Filters contain fan, RC damper module and trap disconnect jumper

Remark: Frame sizes A, B, C do not require air-flow for cooling and hence they are not equipped with FAN.

Note: FN3442 and FN3443 filters are available in -E0XXXX, -E0FAXRX, -E0FAJRX and -E2FAJRX configurations.

2.10 Frame size J Filter configuration (FN3440/41-250-119, FN3450/51-315-119)

E0XXSXX

- For rectifiers without DC-link choke
- Filters contain circuit breaker

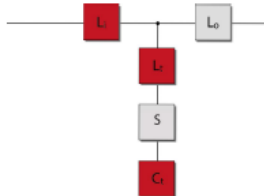

E2FASXX

- For rectifiers without DC-link choke
- Filters contain fan aux. power supply and circuit breaker

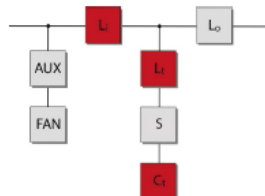

E0XXSXX

- For rectifiers with DC-link choke
- Filters contain circuit breaker

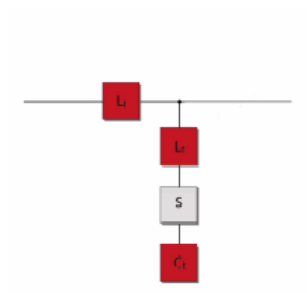

E2FASXX

- For rectifiers with DC-link choke
- Filters contain fan aux. power supply and circuit breaker

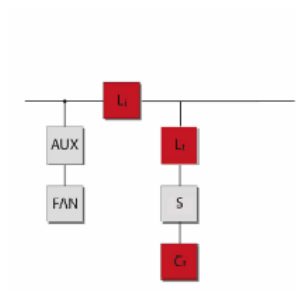

3 Filter description

3.1 General electrical specifications FN3440/FN3441 (50 Hz filters)

Nominal operating voltage:	3x 380 to 415 V AC
Voltage tolerance range:	3x 342 to 457 V AC
Operating frequency:	50 Hz ±1 Hz
Network:	TN, TT, IT
Nominal motor drive input power rating:	1.1 to 250kW
Total harmonic current distortion THDi: ²⁾	<5% @ rated power ¹⁾
Total demand distortion TDD: ²⁾	According to IEEE 519
Efficiency:	≥98% @ nominal line voltage and power
Drive dc-link voltage:	-5% ~ +10% nominal V _{dc}
High potential test voltage: ³⁾	P → E 2160 VAC (1s)
SCCR: ⁴⁾	100kA, fuses according UL class J
Protection category:	IP 00, IP 20
Pollution degree:	PD3 (according to standard IEC 60664-1)
Cooling:	Internal fan cooling or external cooling ⁵⁾
Overload capability:	1.6x rated current for 1 minute, once per hour
Capacitive current @ no load:	<20% of rated input current, at 400 V AC
Ambient temperature range:	-25°C to +45°C fully operational +45°C to +70°C derated operation ⁶⁾ -25°C to +85°C transportation and storage
Flammability class:	UL 94V-2
Insulation class of magnetic components:	N (200°C), H (180°C)
Design corresponding to:	Filter: UL/IEC 61800-5-1, EN 61800-5-1 Chokes: EN 61558-2-20 or EN 60076-6
MTBF @ 45°C/400 V (Mil-HB-217F):	>200,000 hours
MTTR:	<15 minutes (capacitor modules and fan modules)
Lifetime (calculated):	≥10 years
Safety monitor output signal:	Thermal switch NC 180° C (UL-approved) to detect overload of chokes

¹⁾ THDi ~5% at rated power for filter <4kW.

²⁾ System requirements: THVD <2%, line voltage unbalance <1%
Performance specification for six-pulse diode rectifiers. SCR rectifier front-end produce different results, depending upon the firing angle of the thyristors.
Conditions: line impedance <3%

³⁾ Repetitive tests to be performed at max. 80% of above levels, for 2 seconds.

⁴⁾ External UL-rated fuses required.

⁵⁾ Please check the inlet air flow required for cooling in section 3.8.

⁶⁾ $I_{derated} = I_{nominal} \times \sqrt{((70^{\circ}\text{C} - T_{amb}) / 25^{\circ}\text{C})}$

3.2 General electrical specifications FN3450/FN3451 (50 Hz filters)

Nominal operating voltage:	3x 440 to 500 V AC
Voltage tolerance range:	3x 396 to 550 V AC
Operating frequency:	50 Hz ±1 Hz
Network:	TN, TT, IT
Nominal motor drive input power rating:	1.1 to 315kW
Total harmonic current distortion THDi: ²⁾	<5% @ rated power ¹⁾
Total demand distortion TDD: ²⁾	According to IEEE 519
Efficiency:	≥98% @ nominal line voltage and power
Drive dc-link voltage:	-5% ~ +10% nominal V _{dc}
High potential test voltage: ³⁾	P → E 2160 VAC (1s)
SCCR: ⁴⁾	100kA, fuses according UL class J
Protection category:	IP 00, IP 20
Pollution degree:	PD3 (according to standard IEC 60664-1)
Cooling:	Internal fan cooling or external cooling ⁵⁾
Overload capability:	1.6x rated current for 1 minute, once per hour
Capacitive current @ no load:	<20% of rated input current, at 400 V AC
Ambient temperature range:	-25°C to +45°C fully operational +45°C to +70°C derated operation ⁶⁾ -25°C to +85°C transportation and storage
Flammability class:	UL 94V-2
Insulation class of magnetic components:	N (200°C), H (180°C)
Design corresponding to:	Filter: UL/IEC 61800-5-1, EN 61800-5-1 Chokes: EN 61558-2-20 or EN 60076-6
MTBF @ 45°C/400 V (Mil-HB-217F):	>200,000 hours
MTTR:	<15 minutes (capacitor modules and fan modules)
Lifetime (calculated):	≥10 years
Safety monitor output signal:	Thermal switch NC 180° C (UL-approved) to detect overload of chokes

¹⁾ THDi ~5% at rated power for filter <4kW.

²⁾ System requirements: THVD <2%, line voltage unbalance <1%
Performance specification for six-pulse diode rectifiers. SCR rectifier front-end produce different results, depending upon the firing angle of the thyristors.
Conditions: line impedance <3%

³⁾ Repetitive tests to be performed at max. 80% of above levels, for 2 seconds.

⁴⁾ External UL-rated fuses required.

⁵⁾ Please check the inlet air flow required for cooling in section 3.8.

⁶⁾ $I_{derated} = I_{nominal} \times \sqrt{((70^{\circ}\text{C} - T_{amb}) / 25^{\circ}\text{C})}$

3.3 General electrical specifications FN3442/FN3443 (60 Hz filters)

Nominal operating voltage:	3x 380 to 415 V AC
Voltage tolerance range:	3x 342 to 456 V AC
Operating frequency:	60 Hz ±1 Hz
Network:	TN, TT, IT
Nominal motor drive input power rating:	1 to 240 HP (0.9 to 177)
Total harmonic current distortion THDi: ²⁾	<5% @ rated power ¹⁾
Total demand distortion TDD: ²⁾	According to IEEE 519
Efficiency:	≥98% @ nominal line voltage and power
Drive dc-link voltage:	-5% ~ +10% nominal V _{DC}
High potential test voltage: ³⁾	P → E 2160 VAC (1s)
SCCR: ⁴⁾	100kA, fuses according UL class J
Protection category:	IP 00, IP 20
Pollution degree:	PD3 (according to standard IEC 60664-1)
Cooling:	Internal fan cooling or external cooling ⁵⁾
Overload capability:	1.6x rated current for 1 minute, once per hour
Capacitive current @ no load:	<20% of rated input current, at 400 V AC
Ambient temperature range:	-25°C to +45°C fully operational +45°C to +70°C derated operation ⁶⁾ -25°C to +85°C transportation and storage
Flammability class:	UL 94V-2
Insulation class of magnetic components:	N (200°C), H (180°C)
Design corresponding to:	Filter: UL/IEC 61800-5-1, EN 61800-5-1 Chokes: EN 61558-2-20 or EN 60076-6
MTBF @ 45°C/400 V (Mil-HB-217F):	>200,000 hours
MTTR:	<15 minutes (capacitor modules and fan modules)
Lifetime (calculated):	≥10 years
Safety monitor output signal:	Thermal switch NC 180° C (UL-approved) to detect overload of chokes

¹⁾ THDi ~5% at rated power for filter <4kW.

²⁾ System requirements: THVD <2%, line voltage unbalance <1%
Performance specification for six-pulse diode rectifiers. SCR rectifier front-end produce different results, depending upon the firing angle of the thyristors.
Conditions: line impedance <3%

³⁾ Repetitive tests to be performed at max. 80% of above levels, for 2 seconds.

⁴⁾ External UL-rated fuses required.

⁵⁾ Please check the inlet air flow required for cooling in section 3.8.

⁶⁾ $I_{derated} = I_{nominal} \times \sqrt{((70^{\circ}\text{C} - T_{amb}) / 25^{\circ}\text{C})}$

3.4 General electrical specifications FN3452/FN3453 (60 Hz filters)

Nominal operating voltage:	3x 440 to 480 V AC
Voltage tolerance range:	3x 396 to 528 V AC
Operating frequency:	60 Hz ±1 Hz
Network:	TN, TT, IT
Nominal motor drive input power rating:	1.5 to 300 HP (1.1 to 224)
Total harmonic current distortion THDi: ²⁾	<5% @ rated power ¹⁾
Total demand distortion TDD: ²⁾	According to IEEE 519
Efficiency:	≥98% @ nominal line voltage and power
Drive dc-link voltage:	-5% ~ +10% nominal V _{DC}
High potential test voltage: ³⁾	P → E 2160 VAC (1s)
SCCR: ⁴⁾	100kA, fuses according UL class J
Protection category:	IP 00, IP 20
Pollution degree:	PD3 (according to standard IEC 60664-1)
Cooling:	Internal fan cooling or external cooling ⁵⁾
Overload capability:	1.6x rated current for 1 minute, once per hour
Capacitive current @ no load:	<20% of rated input current, at 400 V AC
Ambient temperature range:	-25°C to +45°C fully operational +45°C to +70°C derated operation ⁶⁾ -25°C to +85°C transportation and storage
Flammability class:	UL 94V-2
Insulation class of magnetic components:	N (200°C), H (180°C)
Design corresponding to:	Filter: UL/IEC 61800-5-1, EN 61800-5-1 Chokes: EN 61558-2-20 or EN 60076-6
MTBF @ 45°C/400 V (Mil-HB-217F):	>200,000 hours
MTTR:	<15 minutes (capacitor modules and fan modules)
Lifetime (calculated):	≥10 years
Safety monitor output signal:	Thermal switch NC 180° C (UL-approved) to detect overload of chokes

¹⁾ THDi ~5% at rated power for filter <4kW.

²⁾ System requirements: THVD <2%, line voltage unbalance <1%
Performance specification for six-pulse diode rectifiers. SCR rectifier front-end produce different results, depending upon the firing angle of the thyristors.
Conditions: line impedance <3%

³⁾ Repetitive tests to be performed at max. 80% of above levels, for 2 seconds.

⁴⁾ External UL-rated fuses required.

⁵⁾ Please check the inlet air flow required for cooling in section 3.8.

⁶⁾ $I_{derated} = I_{nominal} \times \sqrt{((70^{\circ}\text{C} - T_{amb}) / 25^{\circ}\text{C})}$

3.5 Additional electrical specifications

Ecosine Evo Passive Harmonic Filters general electrical specifications refer to operating altitudes up to 2000m (6600ft) above sea level.

Operation between 2000m and 4000m (6600ft and 13123ft) requires a derating for clearance and current.

3.5.1 Clearance derating by altitude

Table 16 Altitude correction factors for clearances (extract from table A.2 in IEC 60664-1)

Altitude [m]	Normal barometric pressure	Multiplication factor for clearances
[m]	[kPa]	
2'000	80.0	1.00
3'000	70.0	1.14
4'000	62.0	1.29

3.5.2 Current derating by altitude

The current derating is the factor to which the nominal current needs to be multiplied. A simplified equation can be defined as function of ΔH ($H - 2000$). This equation is valid for H up to 4000 meters ($\Delta H = 2000$ m).

$$\text{Current derating } [I_n^{-1}] = -5 * 10^{-5} * \Delta H + 0.9937$$

Example: at an altitude of 3'500m, we get $\Delta H = 1'500$ m and the current derating = 0.9187. A filter with a rated current of 100A can only be used up to 91.87A.

Remark: Do not use Ecosine Evo Passive Harmonic Filters in altitudes above 4000m without consulting Schaffner first.

3.6 Screw size, torque and cable cross-section requirement

3.6.1 Power terminals

The cable cross-section must be selected according to the rated filter input current, the maximum current, the environment and other special requirements of the application. It should be stranded copper wire cable with a temperature rating of $\geq 75^\circ\text{C}$. Recommended cable cross-section is given in Table 17. The customer is fully responsible to define the most appropriate conductor type according to the application and ensure a proper connection of the filter.

Table 17 Ecosine Evo filter power terminals designation

Terminal designation	Screw thread	Flex wire AWG	Flex wire	Screw torque value	Max width cable lug*	Frame size
			[mm ²]			
110	M3	14-22	0.4-2.5	0.5	7	A
112	M4	10-22	0.4-6	1.2	10	B, C
113	M6	6-18	0.75-16	3	15	D
115	M8	1/0-8	10.50	8	15	E, F
116	M8	3/0-8	10-95	8	17	G
118	M10	3/0-500 kcmil	95-240	10	35	H
119	M16	350-750 kcmil	95-240	10	35	J

* Recommended connector type: wire or cable lug for 110 to 113, only cable lug for 115 to 118

** To fulfill creepage/clearance acc. UL 61800-5-1 without additional protection (insulation). Creepage/clearance can vary depending on applicable standard and must be reviewed by customer. Creepage/clearance may be reduced when additional protection (insulation) is provided.

3.6.2 Trap disconnect jumper terminals

As for power terminals, the cable cross-section of cables connected to and from the trap disconnect jumper terminals must be selected according the rated and maximum current in the trap circuit of the filter, the environment and other special requirement of the application. It should be stranded copper wire cable with a temperature rating of $\geq 75^{\circ}\text{C}$. The terminals models are the same as used for the power terminals but with different sizes per frame size. Refer to the terminal designation or filter frame size in Table 18 to select a recommended cable cross-section. The customer is fully responsible to define the most appropriate conductor type according to the application and ensure a proper connection of the filter.

Table 18 Ecosine Evo filter trap disconnect jumper terminals designation

Terminal designation	Screw thread	Flex wire AWG	Flex wire	Screw torque value	Max width cable lug*	Frame size
			[mm ²]			
110	M3	14-22	0.4-2.5	0.5	7	A, B, C
112	M4	10-22	0.4-6	1.2	10	D
113	M6	6-18	0.75-16	3	15	E, F, G
115	M8	1/0-8	10.50	8	15	H

3.6.3 Auxiliary signal and earth terminals

The auxiliary signal and earth terminals screw size and torque is given in Table 19.

Table 19 Ecosine Evo filter signal and earth terminals

Terminal type	Screw thread	Screw torque value [Nm]	Frame size
Signal	M3*	0.5	All
Earth (PE)	M5	2.2	A
Earth (PE)	M6	4	B, C
Earth (PE)	M8	9	D, E
Earth (PE)	M10	17	F, G, H
Earth (PE)	M12	25	J

* Max width cable lug = 7 mm

3.7 Thermal protection switch specifications

One choke of each type is equipped with a thermal protection switch (temperature switch). The 2 or 3 switches (depending on the filter series) are connected in series to the auxiliary terminal TS-TS'. If the temperature switch reaches the nominal switching temperature (NST), the switch will open.

Table 20 thermal protection switch specifications

Contact type	Normally closed (NC)
Nominal switching temperature (NST)	180°C
Resetting temperature (RST)	145°C (indication only)
Operating voltage	Up to 250V AC
Rated current AC I_{nom}	2.5A $\cos\phi = 1.0$ 1.6A $\cos\phi = 0.6$ 1.8A $\cos\phi = 0.4-0.5$

3.8 Cooling requirement

Inlet air flow requirements for each frame size are listed in Table 21. Please notice that the filters with frame size A, B and C do not require air cooling. For frame sizes D to J, the required inlet air flow should be fulfilled, either by including the optional fan module or by providing sufficient external air flow.

Table 21 Air flow required for cooling

Frame size	Min air volume*	
	[m3/h]	CFM [ft3/min]
A, B, C	0	0
D	128	75
E	204	120
G	408	240
H	612	360
J	816	480

Remark: External air flow is required for the cooling at filter's inlet as defined in the table only for filters without embedded ventilation.



Important: The required inlet air flow must be provided to guarantee normal operation of the filter. Insufficient inlet air flow or blocking of air channel might cause overheating of filter components.

3.9 Mechanical frame sizes

Ecosine Evo Passive Harmonic Filters are implemented on a base plate or base frame featuring 9 different frame sizes, Frame A to Frame J, from the lowest to the highest rating. Dimensions and footprint are provided in section 3.10.

In particular, frame sizes A to C do not require air flow, while frame sizes D to J need embedded fan or external ventilation, details are provided in filter selection tables, Table 2 to Table 9. The overview of all frame sizes in IP 00 and IP 20 are shown in Figure 2 and Figure 3.



Figure 2 Overview of all IP 00 frame size versions



A B C D E F G H J
 No ventilation needed Air flow(embedded or external) for cooling required

FN3440 / FN3441	1.1kW	→	250kW
FN3450 / FN3451	1.1kW	→	315kW
FN3442 / FN3443	1.0HP	→	240HP
FN3452 / FN3453	1.5HP	→	300HP

Figure 3 Overview of all IP 20 frame size versions

3.10 Ecosine Evo filter footprint

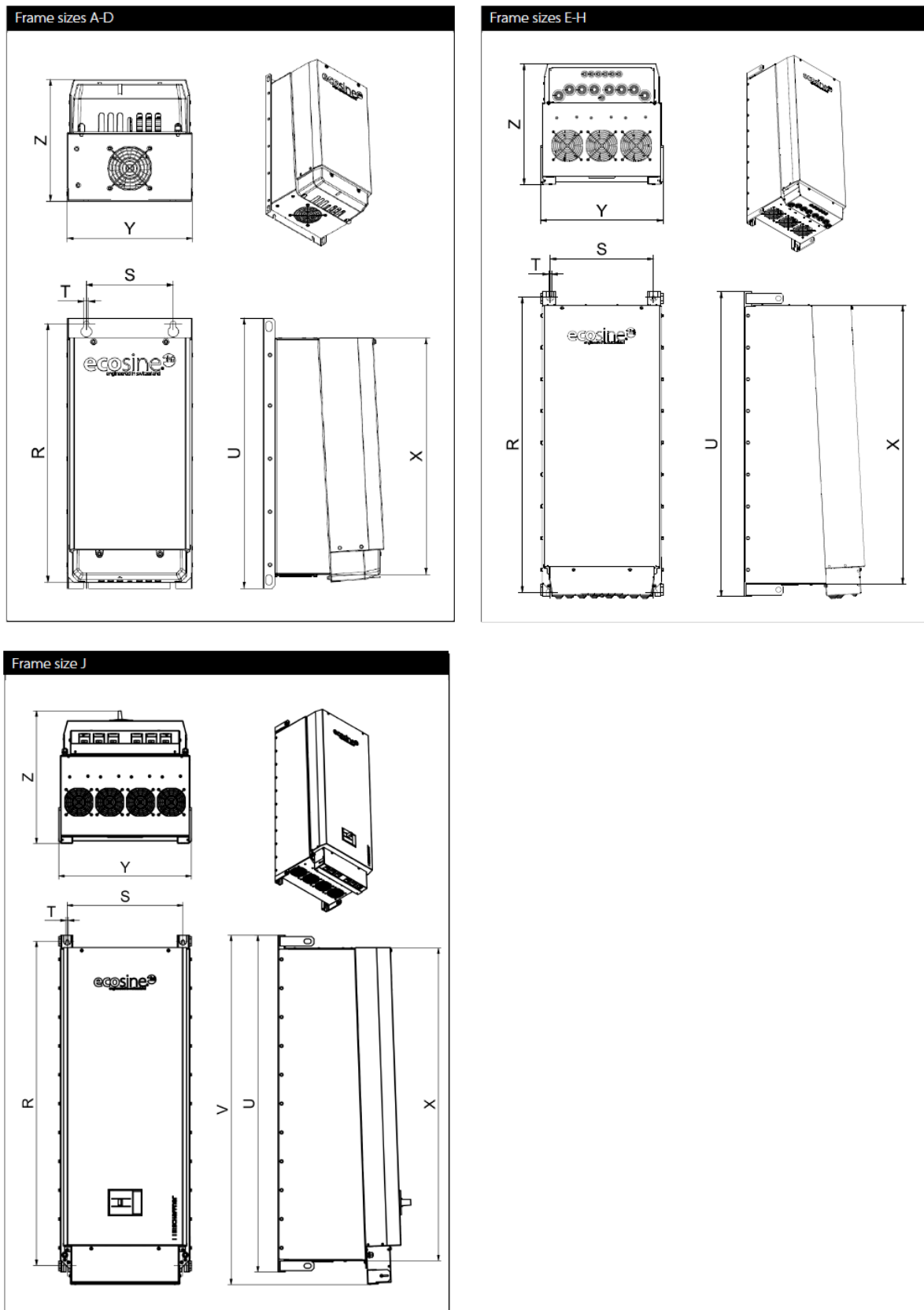

Figure 4 Mechanical Data of FN3440, FN3450, FN3442 and FN3452

Table 22 Dimensions of all frame sizes

Frame	Dimensions in [mm]							Dimensions in [in]						
	Drill pattern			Base U	Volume			Drill pattern			Base U	Volume		
	R	S	T		X	Y	Max. Z	R	S	T		X	Y	Max. Z
A	340	120	7	360	302	160	185	13.4	4.7	0.3	14.2	11.9	6.3	7.3
B	405	120	7	425	370	180	206	15.9	4.7	0.3	16.7	14.6	7.1	8.1
C	460	150	7	483	430	210	221	18.1	5.9	0.3	19.0	16.9	8.3	8.7
D	540	180	11	560	491	260	252	21.3	7.1	0.4	22.0	19.3	10.2	9.9
E	680	220	11	705	635	290	318	26.8	8.7	0.4	27.8	25.0	11.4	12.5
F	730	250	11	752	684	340	343	28.7	9.8	0.4	29.6	26.9	13.4	13.5
G	920	280	11	960	863	353	396	36.2	11.0	0.4	37.8	34.0	13.9	15.6
H	1115	390	11	1150	1053	462	456	43.9	15.4	0.4	45.3	41.5	18.2	18.0
J	1348	480	11	1400	1300	550	555	53.1	18.9	0.4	55.1	51.2	21.7	21.9

For Dimensions without Tolerances: ISO2768-m/EN22768-m applies

3.11 Filter performance

Ecosine Evo Passive Harmonic Filters achieve 5% THDi with 6-pulse diode rectifiers under the following condition.

- Filter is applied to rated voltage and power
- THVD <2%, line voltage unbalance <1%

RC damper module is required to be included in the filter if there is EMI filter present in the drive. Typical expected EMI filter capacitance (phase to star point) are shown in Table 23 and Table 24.

Table 23 Typical expected EMI filter capacitance (phase to star point) for series FN3440/FN3441 and FN3450/FN3451

Filter power range [kw]	EMI filter capacitance [µF]
1.1	1.5
2.2	2.2
4 to 11	3.3
15 to 45	4.7
55 to 250 (315)	10

Table 24 Typical expected EMI filter capacitance (phase to star point) for FN3442/FN3443 and FN3452/FN3453

Filter power range [HP]	EMI filter capacitance [µF]
1.5	1.5
3	2.2
5 to 20	3.3
25 to 60	4.7
75 to 300	10

- Note: 132...200 of FN3440/FN3441 series, 160...250 of FN3450/FN3451 series 200...240HP of FN3442/FN3443 series, and 250...300HP of FN3452/FN3453 series do not need RC damper module when the equivalent phase to star point capacitance of the EMI filter is not bigger than 10 µF.
- 5% THDi is not guaranteed for thyristor rectifier application. The performance of the filter is dependent on the firing angle of the thyristors.

Ecosine Evo filter performance (THDi, power factor and U_{dc}) under different load conditions are shown in the following charts.

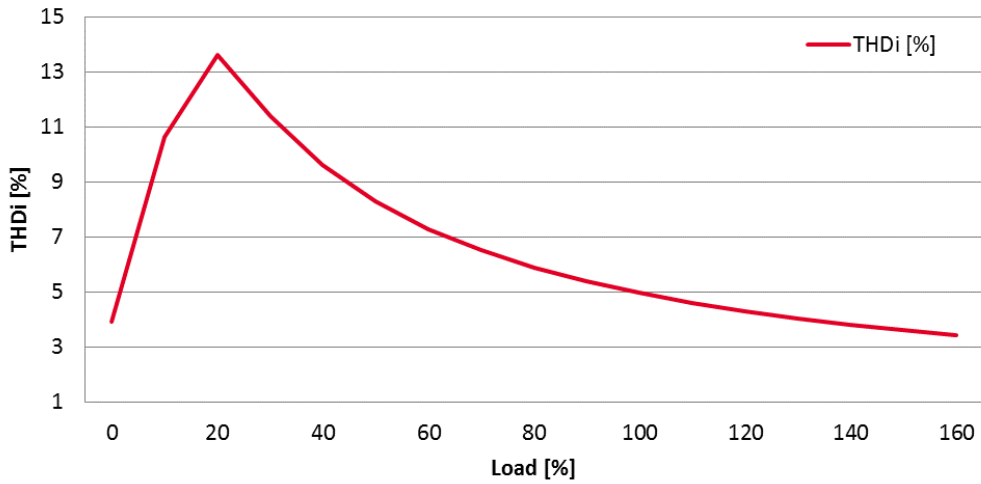

Figure 5 THDi vs. load (diode rectifier front-end)

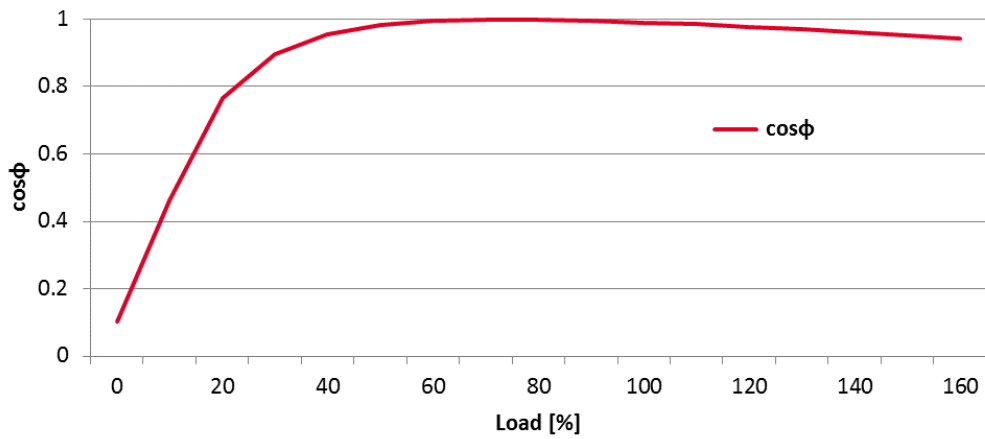

Figure 6 Power factor vs. load (diode rectifier front-end)

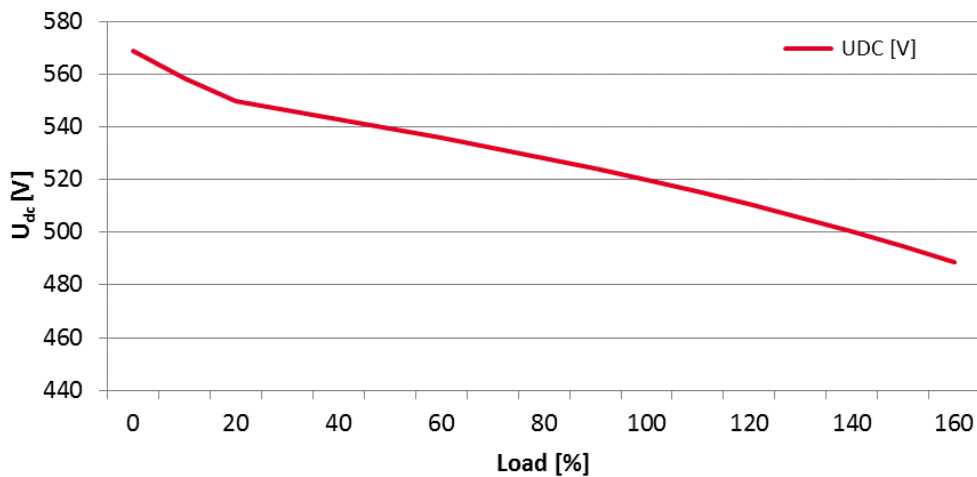
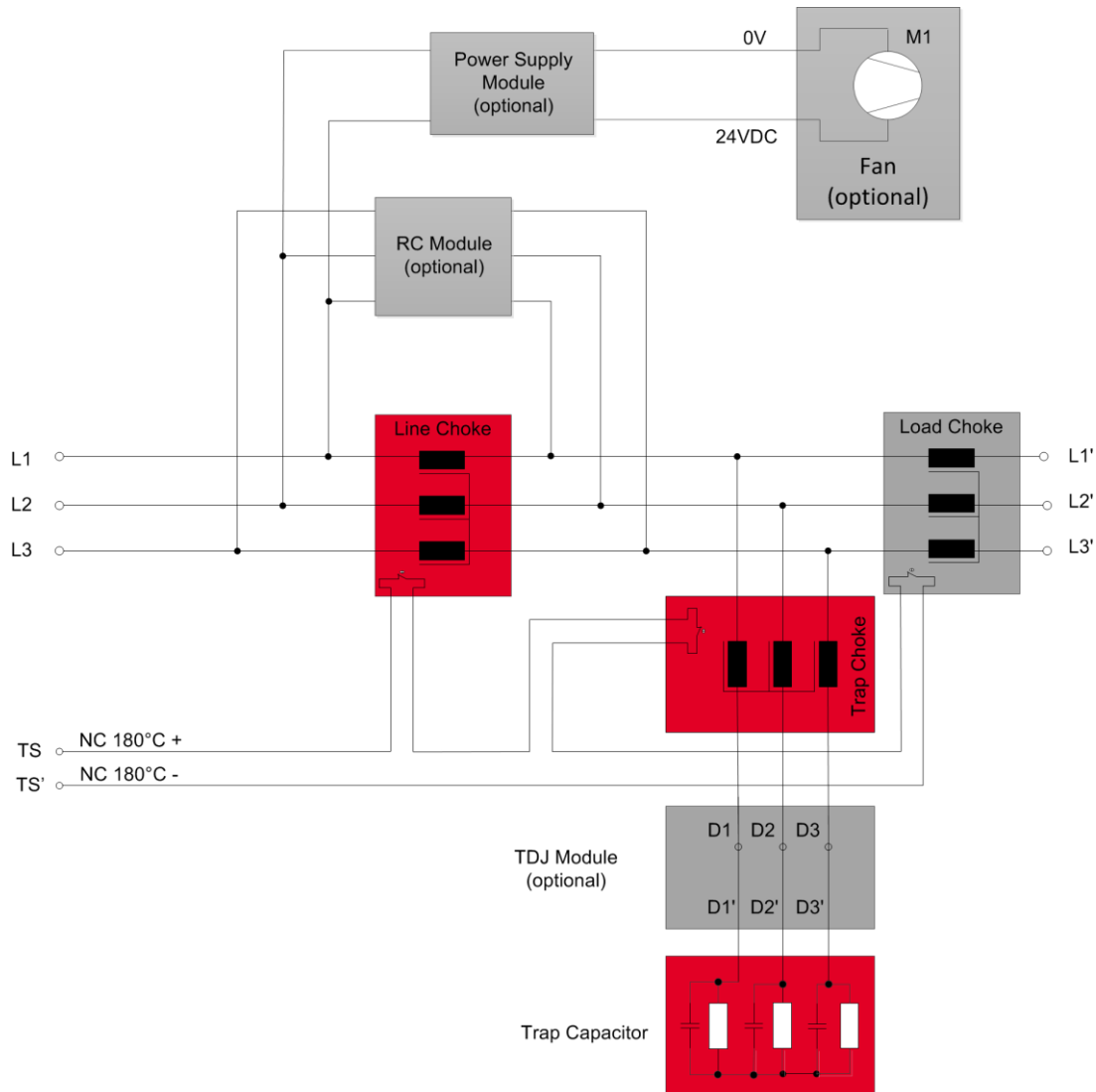

Figure 7 Drive dc-link voltage vs. load (diode rectifier front-end, with FN3440 series)

3.12 Functional diagram



Filter terminals	Line L1/L2/L3	3 terminal blocks
	Load L1'/L2'/L3'	3 terminal blocks
	Signal	Connecting terminals to thermal switch NC 180°C (UL-approved) to detect overload in chokes
	PE	Protective earth. Threaded stud with washer and nut
Function blocks	Chokes	Power magnetic components incl. temperature sensors
	Capacitors	Power capacitors incl. discharge resistors
	Fan	Field replaceable fan for choke air cooling
	Power supply	Internally generate 24 V DC source for fan supply
	RC damper	RC damper module, as option configurable in case of rectifier equipped with EMI filter

4 Modular Design: How to choose optional modules

Ecosine Evo Passive Harmonic Filters provide optimized solution for your application by merely plugging a new module.

The base module of FN3441, FN3451, FN3443 and FN3453 series contains line choke, trap choke and trap capacitor, which helps reduce THDi to 5% for motor drives with an 8% DC-link choke present.

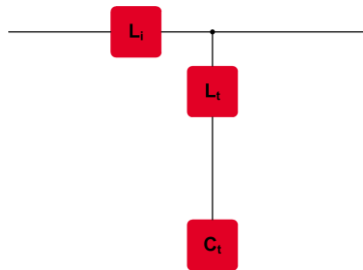

Figure 8 Base module of FN3441, FN3451, FN3443 and FN3453 filter series

The base module of FN3440, FN3450, FN3442 and FN3452 series contains line choke, load choke, trap choke and trap capacitor, which helps reduce THDi to 5% for motor drives without DC-link choke present. The base module schematic is shown in Figure 9.

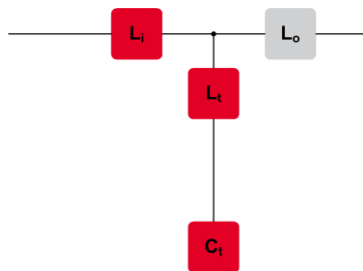

Figure 9 Base module of FN3440, FN3450, FN3442 and FN3452 filter series

General working principle of Ecosine Evo filter base modules is shown in Figure 10.

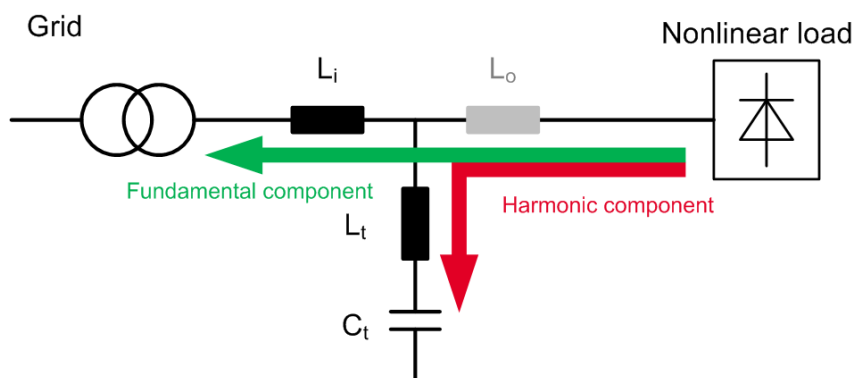

Figure 10 Working principle of Ecosine Evo base modules (with load choke L_o and without)

There are five optional modules available for FN3440/FN3441, FN3450/FN3451, FN3442/FN3443 and FN3452/FN3453 filters:

- Fan and aux. power supply module
- Fan only module
- Trap disconnect jumper module
- Switch module (only for frame J)
- RC damper module

Figure 11 shows a summary of optional modules in use with Ecosine Evo Passive Harmonic Filters.

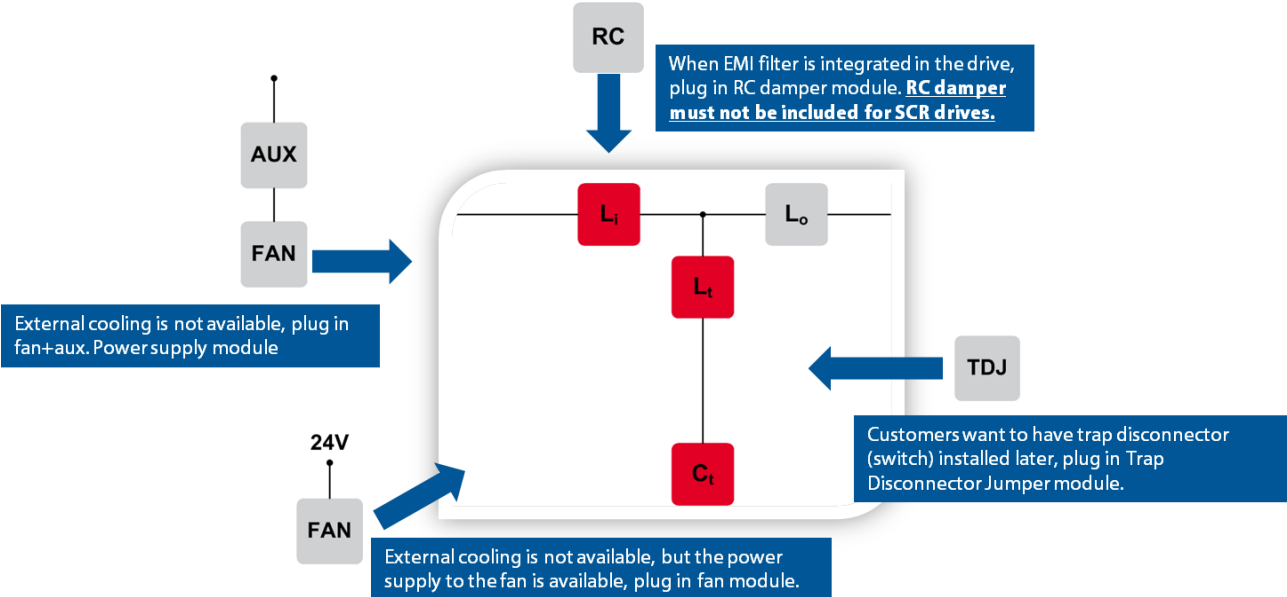

Figure 11 Optional modules for Ecosine Evo filter and according to your requirement and installation

5 Filter appearance and elements

The very compact and neat design of Ecosine Evo Passive Harmonic Filters is realized by a two-stage construction. The filter constructions of all frame sizes are identical, except the position of the load choke. The load choke is built on the upper-stage of the filter for frame size A- F, and on the lower-stage of the filter for frame sizes G – H, which are explained in detail in the following sections.

5.1 IP 00 version, frame size A - F

The general design of the Ecosine Evo Passive Harmonic Filters IP 00 versions with fan module, aux. power supply module, TDJ module and RC damper module (E0FAJRX) is shown in Figure 12. There are load choke L_o , trap capacitor C_t , trap disconnect jumper, power terminal and fan module visible on the upper-stage. The design and construction of the lower-stage is shown in Figure 13. The line choke L_l , trap choke L_t , RC damper module are constructed on the base plate, which contains screw holes for wall mounting.

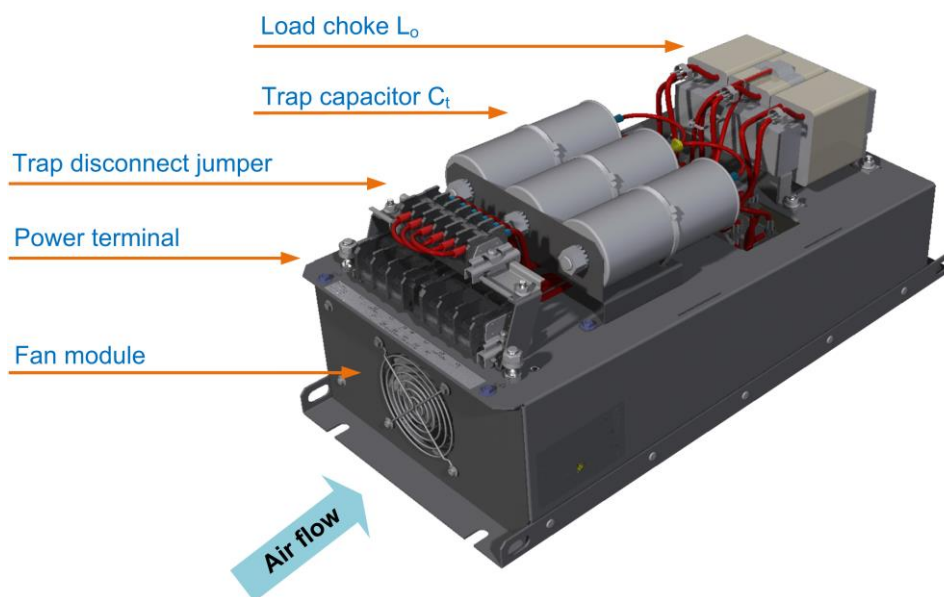

Figure 12 Design of Ecosine Evo filter (Type E0FAJRX, frame size D): Upper-stage

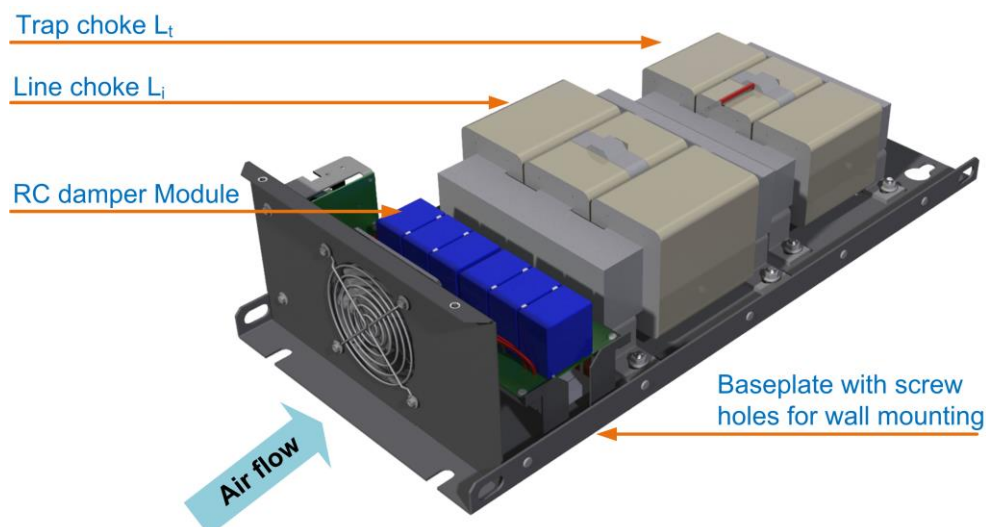

Figure 13 Lower-stage of Ecosine Evo filter (Type E0FAJRX, frame size D): lower-stage

5.2 IP 00 version, frame size G - H

The design of the Ecosine Evo filter IP 00 versions with fan module, aux. power supply module, TDJ module and RC damper module (E0FAJRX) is shown in Figure 14.

There are trap capacitor C_t , trap disconnect jumper, power terminal visible on the upper-stage. The fan module is visible between the upper and lower stage. The design and construction of the lower-stage is shown in Figure 15. The line choke L_i , trap choke L_t , load chock L_o , RC damper module are constructed on the base plate, which contains screw holes for wall mounting.

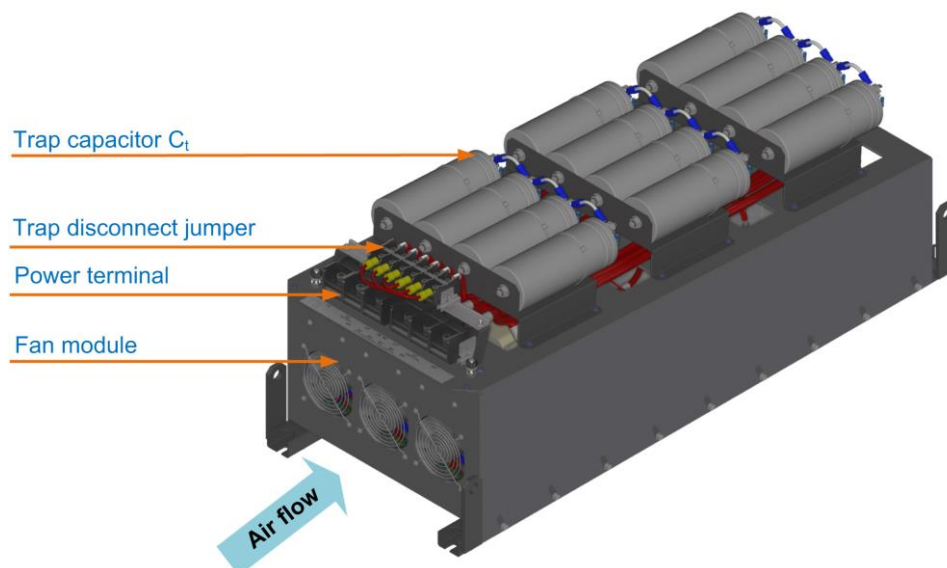

Figure 14 Design of Ecosine Evo filter (Type E0FAJRX, frame size H): Upper-stage

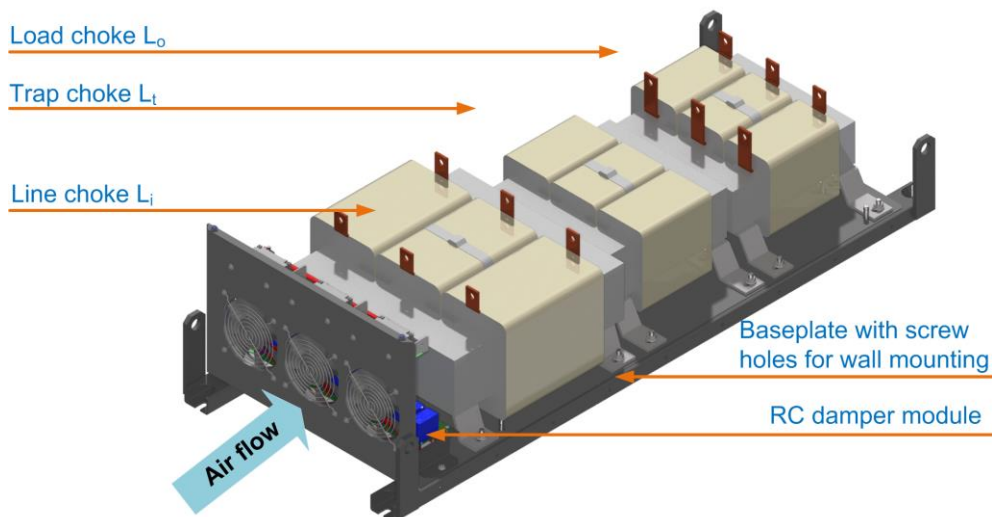

Figure 15 Design of Ecosine Evo filter (Type E0FAJRX, frame size H): Lower-stage

5.3 IP 00 version, frame size J

FN3440/41-250-119 and FN3450/51-315-119 are constructed with frame size J, which is the biggest among all the frame sizes used for Ecosine Evo series. The IP00 version of frame size J contains only switch module, without other optional modules.

There are trap capacitor C_t , switch module (circuit breaker), power terminal visible on the upper-stage, which is presented in Figure 16. The design and construction of the lower-stage is shown in Figure 17. The line choke L_i , trap choke L_t , load chock L_o , are constructed on the base plate, which contains screw holes for wall mounting.

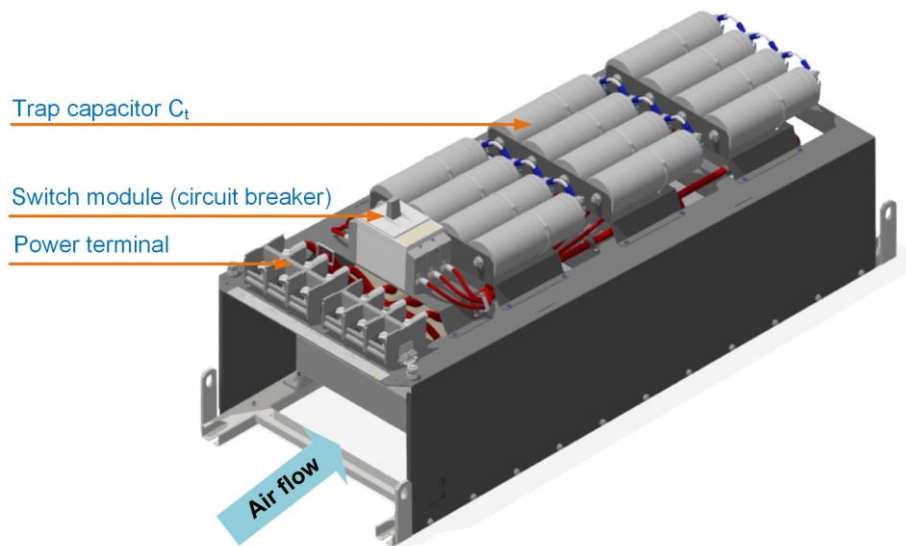

Figure 16 Design of Ecosine Evo frame J, E0XXSXX: Upper-stage

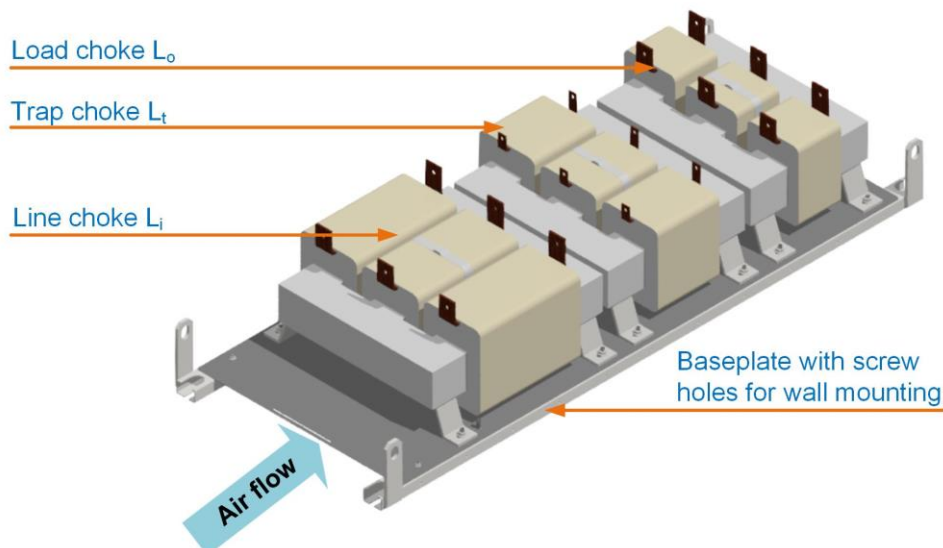

Figure 17 Design of Ecosine Evo frame J, E0XXSXX: Lower-stage

Switch module, namely a circuit breaker, is required for frame size J for safety reasons. The short circuit current of FN3440/41-250-119 and FN3450/51-315-119 (constructed with frame J) can go beyond 10'000A, however the capacitors are only protected with failure current of max. 10'000A. Therefore, an external switch to switch off the capacitors is mandatory to ensure the installation safety at all operation situations. Circuit breaker will be released under overloading and short circuit conditions. When the filter is overloaded, depending on the overcurrent value, circuit breaker will release after certain time. The higher the current, the faster will the circuit breaker release. The characteristics curve of current and tripping time and more information can be found in the datasheet of NZMN2-AF175-NA circuit breaker. In case the circuit breaker is released, the connected load must be shut down immediately. Until the failure is investigated, and problem is solved, the circuit breaker can be switched on again to re-start the system.

5.4 IP 20 version

Ecosine Evo Passive Harmonic Filters IP 20 versions are shown in Figure 18 and Figure 19. IP 20 versions of Ecosine Evo filters are additionally equipped with cover and finger guard on top of the IP 00

version filters. IP20 version of frame size J contains fan module, aux. power supply module and switch module (E2FASXX) is shown in *Figure 19*.

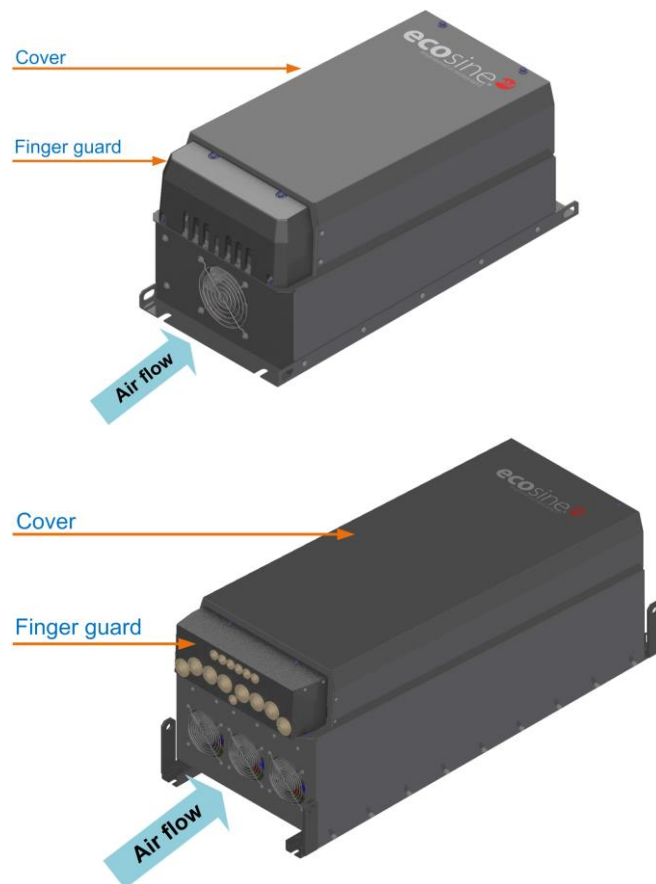

Figure 18 Design of IP 20 version Ecosine Evo filter with frame size D (left) and frame size H (right)

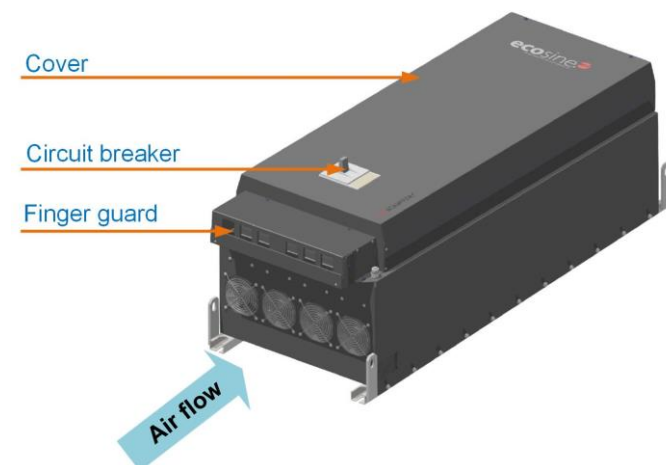

Figure 19 Design of IP 20 version Ecosine Evo filter with frame size J

Parameters of IP 20 enclosure finger guard are shown in Table 25.

Table 25 Parameters of finger guard of IP20 enclosure

Frame size	Finger guard cross-section width /diameter [mm]	Material
A	5.5	Plastic
B	8.0	Plastic
C	8.0	Plastic
D	11	Plastic
E	14	Metal
F	14	Metal
G	18.5	Metal
H	30	Metal
J	42	Metal

6 Performance estimation using SchaffnerPQS

Ecosine Evo Passive Harmonic Filters are included and can be simulated with the Schaffner Power Quality Simulator SchaffnerPQS pqs.schaffner.com.

By using SchaffnerPQS, users can easily simulate and estimate system performance taking into account the most important design requirements and system's boundary conditions.

schaffner PQS training exercise 1 PQS Power Quality Simulator

PROJECTS EDITOR REPORT PROFILE SUPPORT LOGOUT

SOURCE
SCHAFFNER MITIGATION PRODUCTS
LOADS
3RD PARTY PRODUCTS

SIMULATION RESULTS

I_{rms} : 665.2 A	V_{rms} : 229.5 V	P: 453 kW
I_{max} : 976.9 A	V_{max} : 324.3 V	Q: 59.1 kVar
I_{avg} : 0 A	V_{avg} : 0 V	S: 457 kVA
I_{base} : 664.6 A	V_{base} : 229.4 V	D: 25.2 kVA
THD _i : 4.42 %	THD _v : 0.56 %	Seq _u : 458 kVA
PWHD _i : 6.38 %	PWHD _v : 1.68 %	cosφ: 0.99
		PF: 0.99

Please select a standard

7 Filter application

Ecosine Evo Passive Harmonic Filters are designed to mitigate harmonic current of non-linear loads, particularly of three-phase diode-type rectifiers. Contrary to “bus-applied or PCC (Point of Common Coupling)” filters, which are being installed e.g. at the main feeder, they are specifically designed to be used with either an individual non-linear load, or with a group of non-linear loads.

One advantage of load-applied filtering is the fact that the upstream power (relative to the harmonic filter) is clean, i.e. unloaded by the harmonics. This can be of vital importance when the same power bus supplies both motor drives and sensitive loads. Ecosine Evo Passive Harmonic Filters are also suitable for paralleling lower power non-linear loads on a higher power harmonic filter to improve overall system economy. In this case the total expected load power of all connected drives must match the filter.

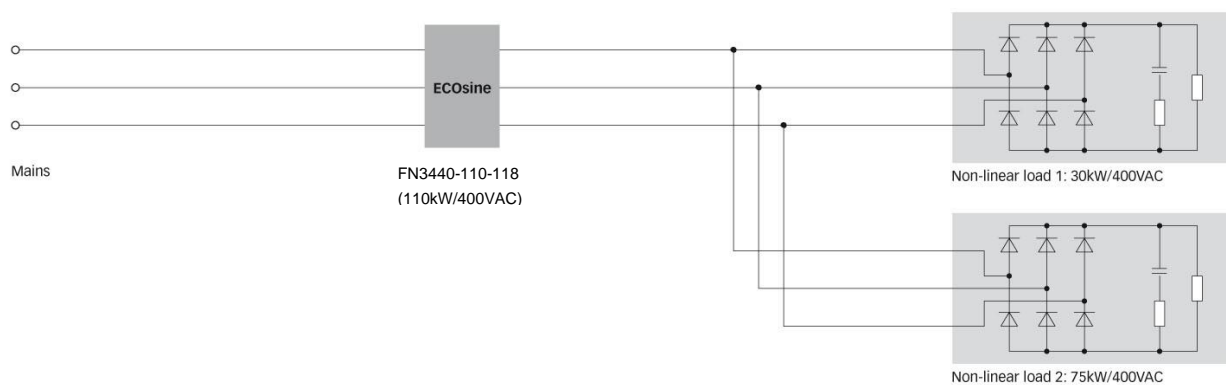

If the expected input power exceeds the rating of the largest available Ecosine Evo filter, the Ecosine Max Passive Harmonic Filter series are more suitable, starting at 250kW and up to 500kW.

8 Filter installation

Please follow the simple steps below to ensure a safe and reliable filter function for many years. Please do also always follow the general safety and installation guidelines provided within this document as well as relevant local, national or international standards that are applicable. Please note that the following installation steps are applicable for both IP 00 and IP 20 enclosure.

8.1 Step 1: Visual inspection

All Schaffner Ecosine Evo Passive Harmonic Filters have undergone rigorous testing before they left our ISO 9001:2015 certified factories. They are packaged with great care in a sturdy container for international shipment.

However, carefully inspect the shipping container for damage that may have occurred in transit. Then unpack the filter and carefully inspect for any signs of damage. Keep the shipping container for future transportation of the filter.

In the case of damage, please file a claim with the freight forwarder involved immediately and contact your local Schaffner partner for support. Under no circumstances install and energize a filter with visible transportation damage.

If the filter is not going to be put in service upon receipt, store within the original container in a clean, dry location, free of dust and chemicals and with respect to named temperature limits, see section 3.2.

8.2 Step 2: Mounting

Ecosine Evo Passive Harmonic Filters are best installed as close as possible to the non-linear load. Ideally they are mounted next to the rectifier or motor drive inside the electrical cabinet or control room. All Ecosine Evo Passive Harmonic Filters FN3440/FN3441, FN3450/FN3451, FN3442/FN3443, FN3452/FN3453 are designed for wall-mounting installation.



It is forbidden to mount Ecosine Evo Passive Harmonic Filters in flat position or any other position than wall-mounting in upward position (cable entry from the bottom) as stated in this manual.

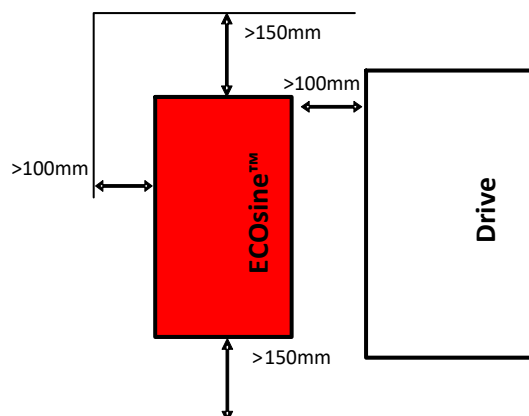

8.2.1 Fixation

Screw hole positions for wall mounted filters (as indicated in Table 26):

Table 26 Dimensions of frame sizes

Frame	Drill pattern [mm]		
	R	S	T
A	340	120	7
B	405	120	7
C	460	150	7
D	540	180	11
E	680	220	11
F	730	250	11
G	920	280	11
H	1115	390	11
J	1348	480	11

All dimensions in mm; 1 inch = 25.4mm

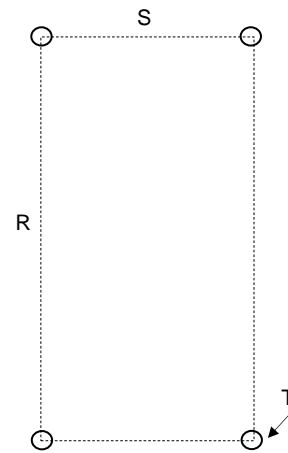

8.2.1 Screws and bolts selection

Screw selection: Schaffner recommends zinc coated hex ribbed flange steel bolts. Respect filters weight for appropriate choice of screws! Head diameters must not exceed these dimensions:
M6: $d \leq 14.2\text{mm}$, M10: $d \leq 21.2\text{mm}$

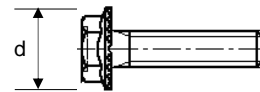

8.2.2 Filter placement:

1. Set screws loose into wall, leave 5mm distance from head to wall.
2. Lift filter with appropriate crane, smallest types (up to 25kg) may be lifted manually by two persons.
3. Place filter first onto lower screws...
4. ...then position it through backplane head openings on upper screws.
5. Fix screws with appropriate torque (depending upon the material of the back plane and local standards).

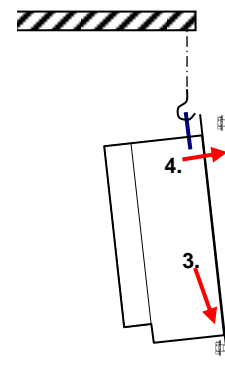

8.3 Step 3: Wiring

8.3.1 Verify safe disconnection of all line side power.

Consult your local safety instructions.



8.3.2 Carefully connect protective earth (PE) wire to adequate earth potential close to ecosine filter.

Use a wire diameter of equal or bigger size as foreseen for line/load side power cables – according to your local codes and safety instructions.

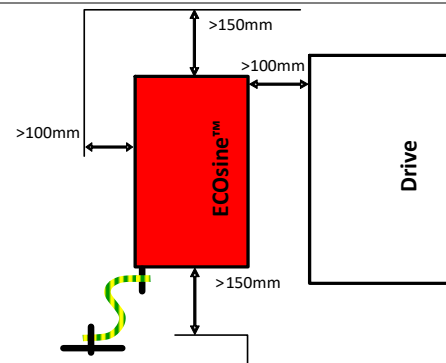

8.3.3 Connect PE wire of ecosine filter

with appropriate cable lug to threaded stud.

- torque M5: 2.2 Nm
- torque M6: 4 Nm
- torque M8: 9 Nm
- torque M10: 19 Nm
- torque M12: 25 Nm

8.3.4 Connect ecosine load side terminals L1', L2', L3' to respective motor drive or rectifier inputs.

The third part of Ecosine Evo designation is a number contains three digits, i.e. FN3440-11-**113**, which indicates power terminal type.

See section 3.6 for the recommended wire size and torque. Use stranded copper wire with a temperature rating of 75°C or higher.

An optional workflow to connect power terminals without having the TDJ module in way is applied. You might consider following these steps:

Connecting power terminals of passive harmonic filters ordered with TDJ module can be facilitated by removing the trap disconnect wires while connecting the cables to the main terminals. Afterwards the trap disconnect jumper cables need to be applied to the original position again. Please follow these steps: Open terminals D1- D1', D2- D2'and D3- D3', remove the wires, add main terminals and then fix wires on terminals D1- D1', D2- D2'and D3- D3' again. The recommended torques given on the terminal label must be applied.

Remarks regarding IP 20 enclosure

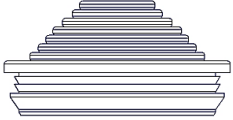
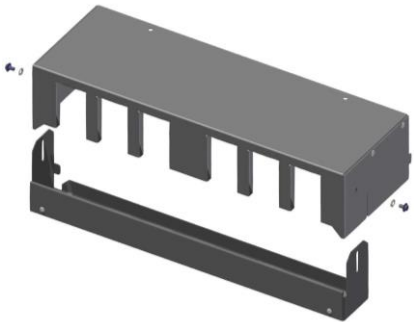
1. To connect Ecosine Evo line and load side terminals, the finger guard has to be removed as a first step, and be installed again when the line and load side terminals are connected. The screw thread and torque value for all the frame sizes are:
 - **Screw thread: M4**
 - **Screw torque value: 2.5Nm**
2. The metal finger guard for frame sizes E, F and G are equipped with grommets, whilst finger guard H is equipped with stepped collars. Modify the stepped collars according to the cable isolated diameter, 5-10mm margin is recommended to feed the cable easier.
 
3. Note that if the cable lug is wider than the cross-section width/diameter of the finger guard (see Table 25), do not add cable lugs before feeding all cables through the finger guard. Crimp cable lug when the cables are fed through the finger guard.
4. Install shrinking tube for the uninsulated cable lug to fulfill the clearance and creepage requirement.
5. To install finger guard for frame size J, firstly connect the load and line side terminals, then install the upper part of the finger guard by placing the cables through the slots and tightening the screw on the top, thirdly close the other part of the finger guard. The bottom part of the finger guard shall be pushed as close as possible to the cable and tighten the other two screws on the sides.
 

Note: In case the cables on the power terminals are installed without cable lug, it is recommended to follow the maintenance manual closely. Maintenance manual is available on your request per Schaffner contact.

8.3.5 Use wired trap circuit or install external capacitive current control.

For configurations with TDJ option (refer to Tables 4, 5, 6), terminals D1- D1', D2- D2' and D3- D3' are delivered with installed jumpers. When interconnected via an external capacitor contactor (not supplied by Schaffner) they allow for load dependent disconnection of the trap circuit, if needed. Therefore, capacitive current can be minimized for low load operation. Estimation of required contactor size: see box to the right.



The use of contactor for capacitor switching is required. Otherwise, the capacitor and switch lifetime may be strongly reduced.

Contactor performance estimate:

Example: FN3440-**55**-115

The nominal power rating in kW multiples 50% and the grid voltage, then divided by the nominal voltage (400 V for FN344x, 480 V for FN345x) is the approximate reactive power

Contactor rating =

$$55kW * 50\% * \frac{V_{grid}}{V_{nom}} =$$

$$55kW * 50\% * \frac{400V}{400V} = 27.5kVAR$$

8.3.6 Connect monitor switch TS- TS'

The monitor switch is a relay contact, which is open in ALARM state. It is constituted by a thermal switch NC 180°C (UL-approved) to detect overload of chokes. It may either be used to remotely disconnect the drive's load via respective input of drive control (check drive manual) or as alarm sensor for system control unit.



An engaged monitor switch must lead to immediate load shutdown and investigation of the problem.

8.3.7 Connect auxiliary switch AS- AS'

(only relevant for **frame J** filter types FN3440/41-250-119 and FN3450/51-315-119)

The auxiliary switch is a contact, which indicates state of circuit breaker. It is closed under normal operation (CB on) and is open in abnormal condition (CB off). Abnormal condition can be a short circuit in the trap capacitors, overcurrent in the trap circuit, too hot ambient temperature or switch-off status in low load condition (use of motor mechanism together with the circuit breaker – check relevant section in user manual).

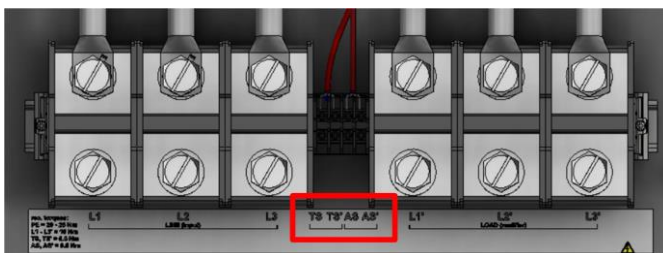

An engaged auxiliary switch must lead to immediate load shutdown and investigation of the problem.

8.3.8 Connect ecosine line side terminals L1, L2, L3

to power input protection (current limiting fuses – see below).

IP 20 enclosure cable wiring please refer to the remarks for the load side cable wiring (8.3.4).

Note: For IP 20 filter versions the IP 20 finger guard must be installed to achieve IP 20 protection. When the finger guard is not installed, Schaffner do not guarantee IP 20 protection.

8.3.9 Fuses

Ecosine Evo Passive Harmonic Filters need external over-current protection for compliance with UL/cUL standard. Fuses and associated fuse holders must be UL listed and rated for 100kA SCCR supplies. Table 27 and Table 28 show requested fuse current ratings for UL class J and, where UL compliance is not mandatory, for IEC class gG. The fuse rating is independent of the supply voltage.

In case of higher power load, Schaffner recommend using Ecosine Max Passive Harmonic Filters, FN347x and FN348x series with rated load power up to 500kW. If for any reason it is still preferred to use Ecosine Evo in parallel, a maximum of two identical filters can be used.

In such system each filter need a separate 3-phase line side fuse block, corresponding to the respective filter and according to Table 27 and Table 28. The drive's application manual may prescribe line-side fuse protection as well, which in this case either corresponds to the sum of the filter fuse ratings or, if lower, would request separate drive fuses at its input.

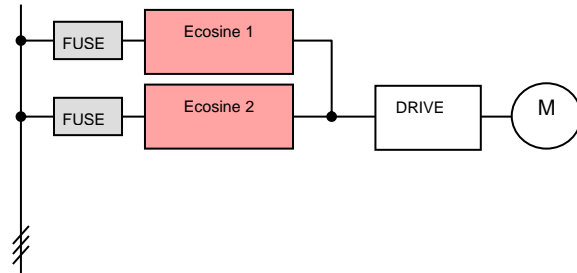

An application, having one ecosine filtering harmonics of several drives, requires in any case line side fuse protection of the drives as well as the correct filter protection according to Table 27 and Table 28.

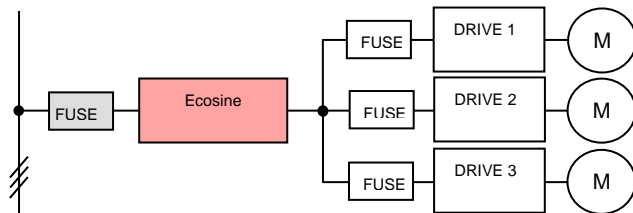

Table 27 Requested fuse current rating for UL class J and for IEC class gG

Ecosine all FN3440	Evo	Ecosine all FN3441	Evo	Ecosine Evo all FN3450	Ecosine Evo all FN3451	Fuse class J rated A	Fuse class gG rated A
				FN3450-1-110	FN3451-1-110	2	2
FN3440-1-110		FN3441-1-110				2.5	2
				FN3450-2-110	FN3451-2-110	4.5	4
FN3440-2-110		FN3441-2-110		FN3450-4-112	FN3451-4-112	8	8
FN3440-4-112		FN3441-4-112		FN3450-6-112	FN3451-6-112	10	10
FN3440-6-112		FN3441-6-112		FN3450-8-112	FN3451-8-112	15	10
FN3440-8-112		FN3441-8-112		FN3450-11-112	FN3451-11-112	20	16
FN3440-11-113		FN3441-11-113		FN3450-15-113	FN3451-15-113	25	20
FN3440-15-113		FN3441-15-113		FN3450-19-113	FN3451-19-113	35	35
FN3440-19-113		FN3441-19-113		FN3450-22-113	FN3451-22-113	40	35
FN3440-22-113		FN3441-22-113		FN3450-30-115	FN3451-30-115	50	50
FN3440-30-115		FN3441-30-115		FN3450-37-115	FN3451-37-115	75	63
FN3440-37-115		FN3441-37-115		FN3450-45-115	FN3451-45-115	80	80
FN3440-45-115		FN3441-45-115		FN3450-55-115	FN3451-55-115	100	100
FN3440-55-115		FN3441-55-115		FN3450-75-115	FN3451-75-115	150	125
FN3440-75-115		FN3441-75-115		FN3450-90-116	FN3451-90-116	175	160
FN3440-90-116		FN3441-90-116		FN3450-110-118	FN3451-110-118	200	200
FN3440-110-118		FN3441-110-118		FN3450-132-118	FN3451-132-118	250	224
FN3440-132-118		FN3441-132-118		FN3450-160-118	FN3451-160-118	300	250
FN3440-160-118		FN3441-160-118		FN3450-200-118	FN3451-200-118	350	300
FN3440-200-118		FN3441-200-118		FN3450-250-118	FN3451-250-118	400	400
FN3440-250-119		FN3441-250-119		FN3450-315-119	FN3451-315-119	600	600

Table 28 Requested fuse current rating for UL class J

Ecosine Evo type all FN3442	Ecosine Evo type all FN3443	Ecosine Evo type all FN3452	Ecosine Evo type all FN3453	Fuse class J rated A
FN3442-1-110	FN3443-1-110	FN3452-1-110	FN3453-1-110	2
FN3442-2-110	FN3443-2-110	FN3452-3-110	FN3453-3-110	4
FN3442-4-112	FN3443-4-112	FN3452-5-112	FN3453-5-112	7
FN3442-6-112	FN3443-6-112	FN3452-8-112	FN3453-8-112	10
FN3442-8-112	FN3443-8-112	FN3452-10-112	FN3453-10-112	15
FN3442-12-112	FN3443-12-112	FN3452-15-112	FN3453-15-112	20
FN3442-16-113	FN3443-16-113	FN3452-20-113	FN3453-20-113	30
FN3442-20-113	FN3443-20-113	FN3452-25-113	FN3453-25-113	35
FN3442-24-113	FN3443-24-113	FN3452-30-113	FN3453-30-113	40
FN3442-32-115	FN3443-32-115	FN3452-40-115	FN3453-40-115	50
FN3442-40-115	FN3443-40-115	FN3452-50-115	FN3453-50-115	60
FN3442-48-115	FN3443-48-115	FN3452-60-115	FN3453-60-115	80
FN3442-60-115	FN3443-60-115	FN3452-75-115	FN3453-75-115	90
FN3442-80-115	FN3443-80-115	FN3452-100-115	FN3453-100-115	125
FN3442-100-116	FN3443-100-116	FN3452-125-116	FN3453-125-116	150
FN3442-120-116	FN3443-120-116	FN3452-150-116	FN3453-150-116	175
FN3442-160-118	FN3443-160-118	FN3452-200-118	FN3453-200-118	250
FN3442-200-118	FN3443-200-118	FN3452-250-118	FN3453-250-118	300
FN3442-240-118	FN3443-240-118	FN3452-300-118	FN3453-300-118	400

9 Filter maintenance

Ecosine Evo Passive Harmonic Filters described in this manual are equipped with long life components that ensure a satisfactory function for many years under normal operating conditions. Any operation under extreme conditions such as over-temperatures, overvoltage situations, polluted environments etc. reduces the life expectancy. The following maintenance recommendations will help maximizing filter lifetime.

Warnings:



High voltage potential is involved in the operation of this product. Always remove line side power before attempting to perform maintenance and let ample time elapse for the capacitors to discharge to safe levels (<42 V). Residual voltages are to be measured both line to line and line to earth.



Line side power must be disconnected prior to replacement of any part.

9.1 Maintenance schedule

Table 29 Maintenance schedule

year	1	2	3	4	5	6	7	8	9	10	11	12
check and clean fan(s)	X	X	X	X	X	X	X	X	X	X	X	X
replace fan(s)					X					X		
check & tighten el. Connections ¹⁾	X	X	X	X	X	X	X	X	X	X	X	X
check el. values of capacitors		X		X		X		X		X		X
replace power capacitors										X		

¹⁾ Only external connections need to be checked.

9.2 Fan

Schaffner Ecosine Evo Passive Harmonic Filters are reliable low maintenance products. Many products like power supplies, inverters or motor drives utilize fans for forced cooling to minimize size and weight. Ecosine filters are designed with a similar temperature management concept and therefore, fans may have to be maintained and replaced at certain intervals to sustain the function and value of the product. Fans are 100% field replaceable without the need to uninstall and disconnect the filter.

Forced cooling devices are needed for the operation of Schaffner Ecosine Evo Passive Harmonic Filters up to their nominal rating. Such cooling devices must be checked and cleaned regularly (if installed) to always ensure sufficient air flow.

Important: increased audible noise is a typical indicator of a fan that needs maintenance or replacement. This could also occur outside of a maintenance schedule.

Before cleaning or replacing the cooling devices, make sure to consult the recommended maintenance procedures and schedules of the supplier of the cooling device in use.

9.3 Power capacitors

The power capacitors supplied with the filter modules are high quality components with an expected lifetime of up to 100'000 hours (11 years). Nevertheless, their useful service life can be shortened by electrical or thermal stress beyond their specification.

Power capacitor damage may also be caused by severe abnormal supply voltage peaks (i.e. lightning – depending upon system protection), but may only be recognizable through the measurement of line side harmonics distortion. This may be checked with a modern energy meter or by regular checkup with a power quality analyzer. According to the above considerations, a 2-year inspection interval is advisable.

Note: an inspection should also be performed after extreme overvoltage situations in the system.

9.3.1 Note regarding the storage of capacitors

Up to 3 years-long storage, electrolytic capacitors can be operated without any restriction and the nominal voltage can be applied without any preliminary preparation. System reliability and lifetime expectancy are not affected.

On the other side, a longer (>3 years) storage of electrolytic capacitors without applying any voltage can weaken the dielectric properties because of dissolution processes. The electrolytic solution is aggressive, and it can affect and weaken the dielectric in the timeframe between production and product commissioning. These weak points are responsible for the higher leakage current shortly after the device is turned on.

The residual current of electrolytic capacitors depends upon time, voltage and temperature. The residual current increases after long storage without applying voltage.

The amplitude of resulting residual current during unit commissioning can be up to 10 times larger in a short term. The capacitor's residual current assumes the typical expected value at steady state for nominal voltage.

During commissioning after long storage, it is recommended to restore the dielectric characteristics by applying voltage progressively and with respect to the time frame the filters have been stored.

9.4 Electrical connections

Depending upon the environment and application, electrical connections, in particular threaded bolts and nuts, can degrade over time by means of losing their initial tightening torque. This holds true not only for the filter, but for any such joint within an electrical installation.

Therefore, Schaffner recommends checking and tightening all electrical connections during regular scheduled maintenance of the entire device that incorporates the filter. Checking of internal connections within the filters is not needed or if needed should only be conducted by a Schaffner service representative.

10 Trap circuit disconnect

The trap circuit disconnect feature, available with the TDJ option, allows to install a contactor for capacitor in the trap circuit. Its purpose is to reduce the capacitive current during low load operation, if needed. With permanently connected trap circuit, $\cos\phi$ vs. load shows following characteristics:

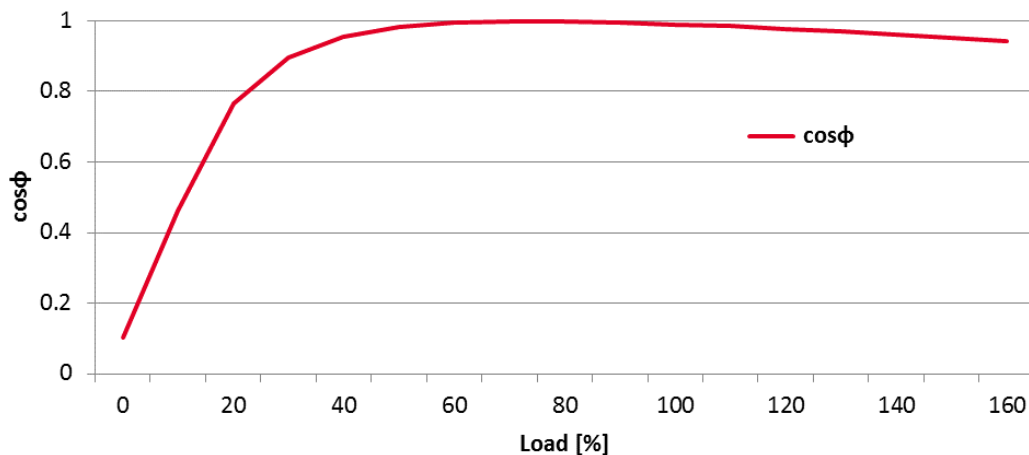

When the trap circuit is disconnected, $\cos(\phi)$ returns to ~ 0.98 . At the same time, the THDi will increase. This THDi increase may be negligible since absolute amplitude of harmonics are low at reduced load power compared to the amplitude at full load.

This feature requires external components (not part of Ecosine filter) and system functions for fully automated capacitive current control:

- Motor load (power factor) monitoring device
- Contactor for capacitor switching

A reduced load system status may be available as system controller output signal. In this case, only adequate driving of capacitor contactor must be assured.

Note: It is necessary to consider the overall concept of power factor correction. A system PFC correction unit with large capacitor banks may become obsolete or massively reduced, when harmonic filters are installed. In such cases it may not be necessary to use the trap circuit disconnect feature.

Recommended settings:

Schaffner recommends engaging and disengaging the trap circuit disconnect at following load levels:

Trap circuit state change to

Disconnected

Connected

Proposed load level

When load level drops under 10–15%

When load level rises above 20–25%

11 Troubleshooting

Schaffner Ecosine harmonic filters are high quality products and have undergone rigorous testing and qualification procedures. Every unit runs through suitable tests in our ISO 9001:2015 factories. Due to this reason no major issues need to be expected if the filter is installed, operated, and maintained as described in this document.

In the unlikely event of a problem, please contact your local Schaffner partner for assistance.

12 Abbreviation

Ecosine Evo: Refer to the product series Ecosine Evo Passive Harmonic Filters

PHF: Passive Harmonic Filter

PWM: Pulse Width Modulation

f_{PWM} : Frequency of the PWM or switching frequency

TDJ: Trap Disconnect Jumper module

[This page is intentionally left blank.]

[This page is intentionally left blank.]

To find your local partner within
Schaffner's global network, please visit
schaffner.com

The information contained within this document and the functions offered are solely intended to provide information about products available for purchase from Schaffner group companies ("Schaffner") and do not constitute an offer for purchase or sale or a recommendation or advice. The content of this document has been carefully prepared and reviewed and all reasonable efforts have been made to ensure the accuracy of the information. However, Schaffner does not warrant the accuracy and does not assume any liability whatsoever for any errors or inaccuracies of this document and the consequences thereof. Schaffner accepts no responsibility or liability for any losses or damages of any kind arising out of the use of this document or any of its related functions. Further, Schaffner cannot be held responsible for any errors or unexpected unfulfillment of shipments. Schaffner reserves the right to make changes to this document, the products, the published specifications and any other functions at any time without notice. Product suitability for any area of application must ultimately be determined by the customer. In all cases, products must never be operated outside their published specifications. Schaffner does not warrant, represent or guarantee the availability of any or all published products. The latest publications and product specification sheets as well as the current Schaffner general terms and conditions and data protection policy apply; these documents and the complete legal disclaimer can be downloaded from the Schaffner website. In order to improve readability, the masculine form is mainly used for people and personal nouns in this document. All references to persons apply equally to all genders. The abbreviated language form has only editorial reasons and does not imply any valuation.

All intellectual property rights, such as trademarks, tradenames, designs and copyrights, are reserved and are exclusively owned by Schaffner Holding AG. This document may exist also in other languages. This version is valid and binding.

This disclaimer shall be governed by substantive Swiss law and resulting disputes shall be settled by the courts at the place of business of Schaffner Holding AG.

© 2023 Schaffner Holding AG

